

# OvaEasy<sup>100</sup> EX CONNECT Series III

Operating Manual

**Brinsea**  
Incubation Specialists



Authorised Representative:  
Authorised Rep Compliance Ltd.  
Ground Floor, 71 Lower Baggot  
Street, Dublin, D02 P593, Ireland  
[www.arc.compliance.com](http://www.arc.compliance.com)



**Read the instructions before use!**

**Damaged appliances shall not be used.**

**The appliance and its supply cord must be placed in an indoor area not subject to splashes of water or wet conditions and protected from or out of reach of animals.**

**Repairs shall be carried out only by a suitably qualified person.**

**This appliance shall not be used, cleaned or maintained by children or persons with reduced physical, sensory or mental capabilities or lack of experience and knowledge without supervision. Children shall not play with the appliance.**

**Ensure that nothing can restrict the movement of the trays or setting shelves. This may damage the turning mechanism and invalidate the guaranty. Load the setting shelves evenly to help prevent imbalanced operation. Ensure trays are pushed to the back of each shelf.**

**Disconnect the incubator from the mains power supply during cleaning. Ensure that all electrical parts are kept dry.**

**Record your appliance serial number here: \_\_\_\_\_**

Please read these instructions carefully before setting up your incubator to achieve best results and keep these instructions safe for future reference.

This document includes recommended procedures for successful hatching but incubation involves the control and manipulation of a large number of factors and in certain circumstances different procedures may be necessary.

For more detailed information on all aspects of egg incubation including helpful advice on getting best results please visit our website at [www.brinsea.co.uk](http://www.brinsea.co.uk).

Your incubator is designed to allow the user to vary the incubation conditions to suit a wide range of species in different ambient conditions and the specific set-up for every situation is beyond the scope of these instructions.

For more information on incubation and hatching please download our FREE Incubation Handbook: [www.brinsea.co.uk/incubationhandbook](http://www.brinsea.co.uk/incubationhandbook)

To register your new Brinsea product please visit [www.brinsea.co.uk](http://www.brinsea.co.uk) within 30 days of purchase and follow the link on the home page to qualify for your free 3 year guarantee. Sign up for the Brinsea Newsletter to receive the latest news and information.

## Contents

Section	Subject	Page
1	Unpacking	4
2	Location and Installation	4
3	Setting Up the Humidity Pump	4
4	The Brinsea Connect App	8
5	Quick Reference	9
6	Digital Control System	11
7	Storage of eggs	14
8	Temperature	14
9	Humidity and Ventilation	15
10	Egg Turning	18
11	Egg Setting	19
12	Periodic Incubation Cooling	20
13	Hatching	21
14	Cleaning up	21
15	Trouble-shooting and Calibration	23
16	Specifications	24

**Fig. 1 Functional Features of the OvaEasy 100 EX Connect Series III Cabinet Incubator**



## 1. Unpacking

Your incubator has been supplied in protective packaging. Please remove all tape, strapping and packing from the incubator parts. Retain the carton and packing materials to enable the unit to be repacked. Please check that parts are all present and undamaged. Damaged appliances shall not be used.

**Check that the electrical supply matches the machine's requirements** (marked on the technical label on the outside of the box and on the top cover of the Incubator). The power cord set must be an appropriately rated and approved cord-set in accordance with the regulations of the country it is used in.

### Carton contents:

- 1 Cabinet Incubator
- 3m Silicone Water Tubing
- 1 Water Pump Capstan
- 1 Water Pump Tube Assembly (2 connectors and fitted tube)
- 1 Rigid Water Pipe
- 1 Water Tray
- 1 Evaporating Block
- 1 Humidity Pump Water Container
- 4 Universal Trays
- 8 Tray Pegs
- 18 Tray Dividers
- 2 Power Cords

## 2. Location and Installation

**THE INCUBATOR MUST BE PLACED IN AN INDOOR AREA NOT SUBJECT TO SPLASHES OF WATER OR WET CONDITIONS AND OUT OF REACH OF ANIMALS AND CHILDREN.**

Your incubator will give best results in a room free from wide temperature variations and with generous ventilation – particularly if several incubators are running at the same time. Ensure that the room temperature cannot drop on a cold night. Ideally thermostatically control the room at between 20 and 25°C (68 and 77°F). Never allow the room temperature to drop below 15°C (59°F) and ensure that the incubator cannot be exposed to direct sunlight.

Always place the incubator upright on a flat level surface off the floor, worktop height is ideal. Ensure the surface is adequate to support the weight of the machine and contents. See weight specifications at the end of this document.

## 3. Setting up the humidity pump



### IMPORTANT

**Do not place the water container on top of the incubator or higher than the incubator. This is to prevent water siphoning through and flooding the incubator.** The water container is best placed next to the incubator on the same surface.

OvaEasy EX Connect Series III incubators use a peristaltic water metering pump to automatically control the relative humidity of the air in the egg chamber. Pumped water is fed to an expanded paper evaporation block where warm air is drawn over the large surface to effectively evaporate all the water (none should collect under normal conditions).

The incubator is supplied with a pre-assembled humidity pump tube. Cut two lengths of the 3mm silicone tubing: one to reach from the water container to the humidity pump and one to reach from the humidity pump to the evaporating block in the bottom of the incubator. Fit the ends of this tube to the connectors on the pre-assembled humidity pump tube.

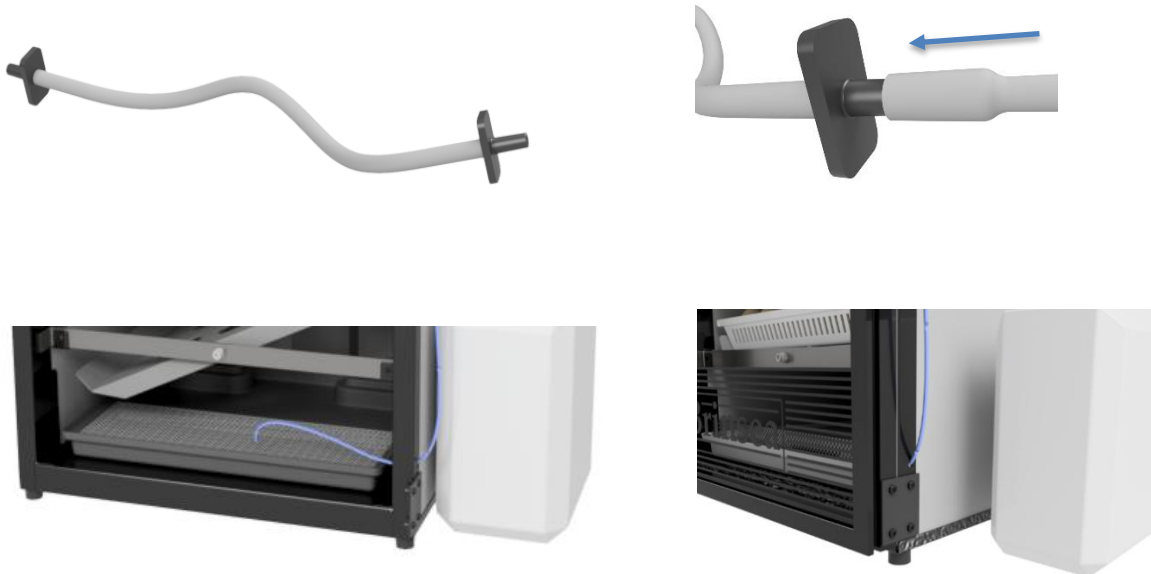

Fit the pump capstan to the pump motor. Align the slot with the shape of the motor shaft. Push the capstan fully home on the motor shaft.

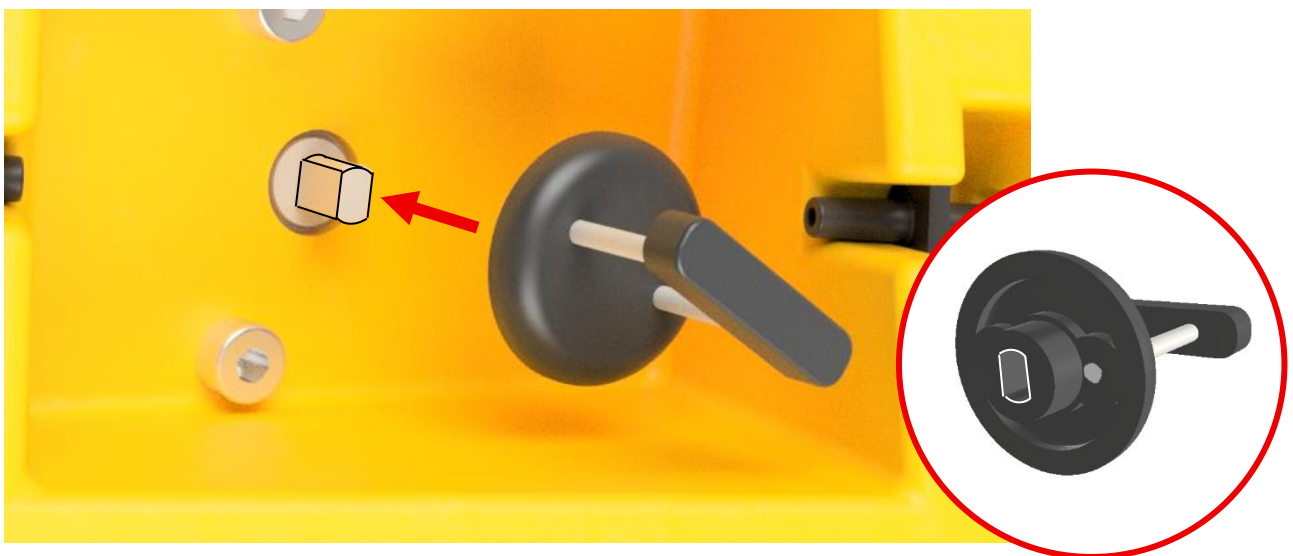

Fit the pump tube to the water pump in three steps. For clarity, only the pump tube is shown here.

**1.**

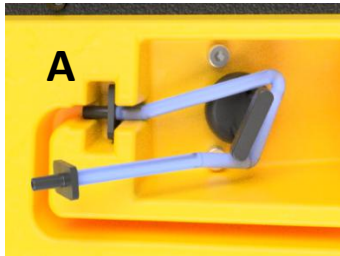

Fit the connector (fitted with the tube for the evaporating block) into the left slot 'A'. Push it fully into the slot.

**2.**



Wrap the pump tube clockwise around the pump capstan.

**3.**



Fit the connector (fitted with the tube for the water container) into the right slot 'B'. Push it fully into the slot.

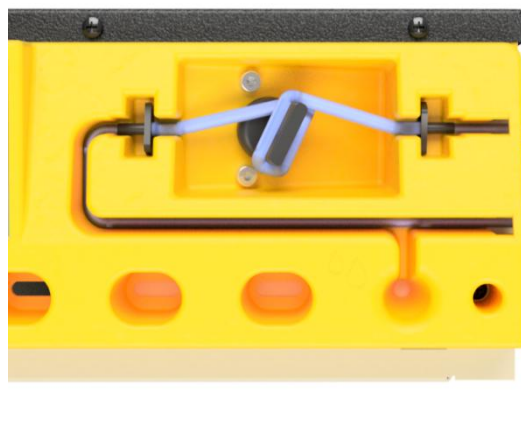

Fit the two lengths of tubing through the slots in the side of the front panel.

To water container

To water evaporating block.

Open the door and place the water evaporation pan in the front of the incubator. Place the Evaporation Block flat across the front of the pan. Slide the pan back into the cabinet so that the evaporation block is at the front of the cabinet.

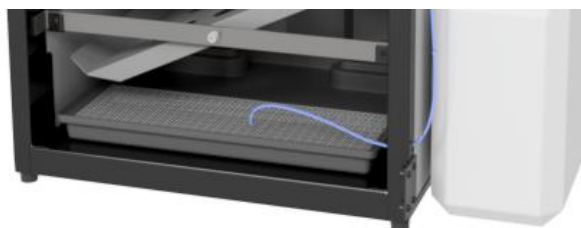
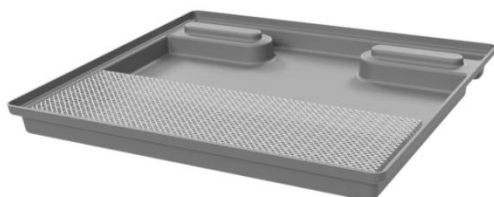

Fit the short, rigid plastic pipe into the end of the silicone tube going to the evaporating block by 12mm (1/2").

Insert the end of the silicone tube with the rigid pipe through the hole by the bottom door hinge.

Open the door and pull enough tube through so that its end may be pushed into the mesh of the evaporating block. As water is pumped out of the tube it will soak into the block and be evaporated by warm air flowing over the block.



The pump is supplied with a length of the thick silicone tube to be fitted around the pump capstan. This length will wear and need periodic replacement. It can also become flattened if left unused for some time because the inside walls of the tube will stick to each other around the capstan and prevent water passing through. Either replace this length of tube with a new 115mm (4.5") length or remove it and roll it between finger and thumb to 'un-stick' it.

**Please note:** The inner ends of the hose connectors must have a short (8mm / 1/3") piece of the thin silicone tube fitted first and the thicker silicone tube fits over the top:

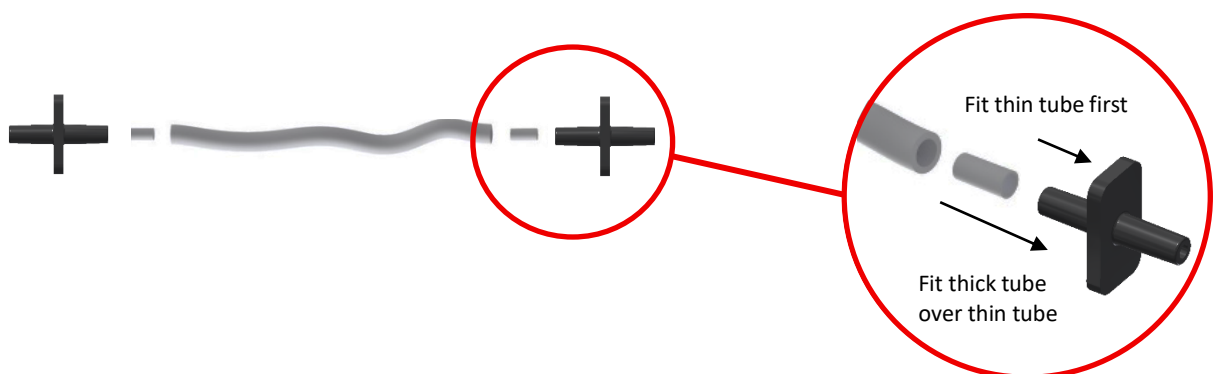

Plug the incubator supply cable into a suitable outlet ensuring that the cable is not pulled tight. The incubator fans will start and the LCD display will show the air temperature and humidity.

## 4. The Brinsea Connect App

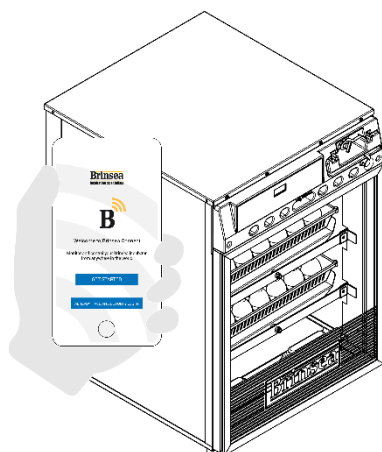

The Brinsea Connect App links to your Connect incubator and means your smartphone can:

- Monitor temperature, humidity, turning, and cooling.
- Be alerted with a phone notification to warning alarms of fluctuations in temperature, humidity and power loss.
- Change temperature, humidity, cooling and turning settings
- Future-proof your incubator/app system with future additional features as they become available.

Remote functions require connection to a Wi-Fi network. The incubator will function normally and there is no risk to incubating eggs if internet connection is lost.

### INSTALL THE APP

In order to use the connected functionality of your OvaEasy EX Connect, you will need to install the Brinsea Connect App on your smartphone.

If you have an Apple device, search the App Store for the Brinsea Connect App.

If you have an Android device, search the Google Play Store for the Brinsea Connect App.

### CONNECT THE INCUBATOR TO A W-FI NETWORK

Once the Brinsea Connect App is installed, follow the instructions on the app to connect your incubator to your home Wi-Fi network.

Make sure you know your home Wi-Fi network ID and password; it will be needed to connect the incubator to the network.

The app contains links to trouble-shooting tips in the Options page Help and Information section.

### INSTALL ANY INCUBATOR SYSTEM UPDATES







Once your incubator has been connected to the Brinsea Server and the Wi-Fi network is available, each time power is disconnected and then reconnected a check will be automatically made for any available incubator control system updates. The control panel on the incubator will show "Update?" when one is available. It is recommended to perform this check when using your incubator for the first time.

Update?  
N Y

Press the + button (Y) to install. This may take several minutes. Do not unplug or turn off your incubator while it is being updated. Updates may include improvements to security or other fixes and it is recommended to install updates when available. If the internet connection is interrupted during an update the system may need to repeat the process.

## 5. Quick Reference (please read relevant section for detail)

This quick reference is intended to allow users to quickly set up the incubator and learn the key features of the control system. Please read the rest of the instructions to obtain a full understanding of each feature.

	PRESS BOTH BUTTONS TO UNLOCK THE MAIN MENU
	SELECT THE OPTION / RETURN TO THE MENU.
	GO FORWARD ONE SCREEN / INCREASE THE VALUE / DISPLAY IN CELSIUS.
	GO BACK ONE SCREEN / DECREASE THE VALUE / DISPLAY IN FAHRENHEIT.
	PRESS BOTH BUTTONS TO SET THE TRAYS LEVEL, FROM LEFT OR RIGHT TO HORIZONTAL.
	INTERNAL LIGHTS ON / OFF.

## CONTROL MENU – QUICK REFERENCE

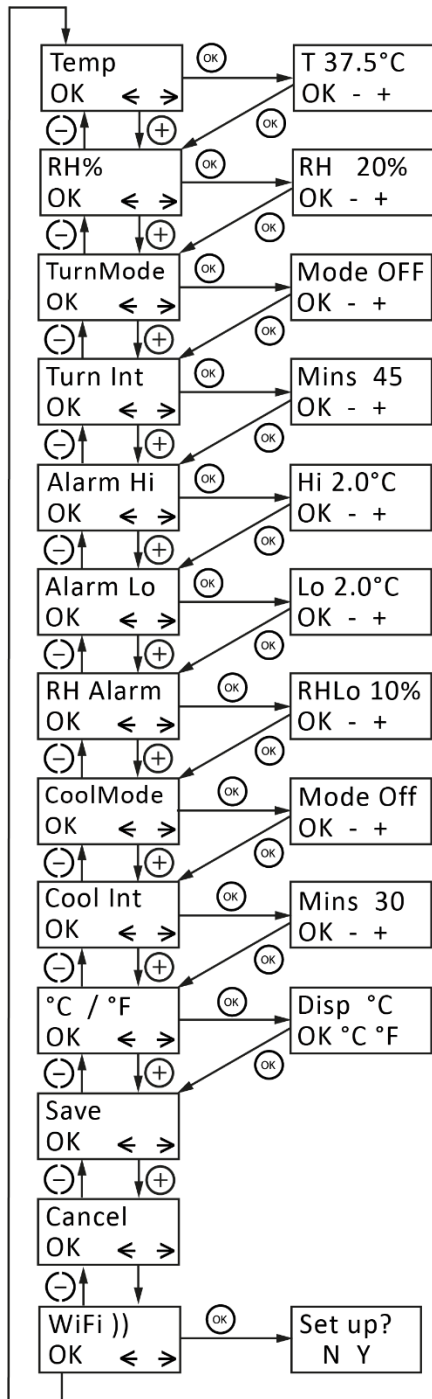

### INCUBATION TEMPERATURE

Range 20.0 – 40.0°C (68.0 – 104.0°F). Default 37.5°C (99.5°F). See section 8.

### RELATIVE HUMIDITY

Range 20% – 80%. Default 20%. See section 9.

### TURNING MODE

Switches the turning system to on or off. Default OFF.

### TURNING INTERVAL

Sets the delay between turns. Range 5 – 180 minutes. Default 45 minutes.

### HIGH TEMPERATURE ALARM

Range 1.0 – 5.0°C (1.8 – 9.0°F) above set incubation temperature. Default 2.0°C (3.6°F). See section 6.

### LOW TEMPERATURE ALARM

Range 1.0 – 5.0°C (1.8 – 9.0°F) below set incubation temperature. Default 3.0°C (5.4°F). See section 6.

### LOW HUMIDITY ALARM

Range 10-50%RH below set humidity. Default 10%RH. See section 6.

### PERIODIC INCUBATION COOLING

Switches heater off for a timed period once every 24 hours. **Do not use before day 7 of incubation or whilst hatching.**

### PERIODIC COOLING INTERVAL

Range 10 – 360 minutes. Default - OFF. See section 12.

### CELSIUS / FAHRENHEIT DISPLAY

Switches all temperature figures between °C and °F. Default °C. See section 8.

### SAVE

All changes are saved. Return to normal operation screen.

### CANCEL

All changes are ignored. Return to normal operation screen.

### Wi-Fi

Enter Wi-Fi setup mode when using Brinsea Connect App.

## 6. Digital Control System

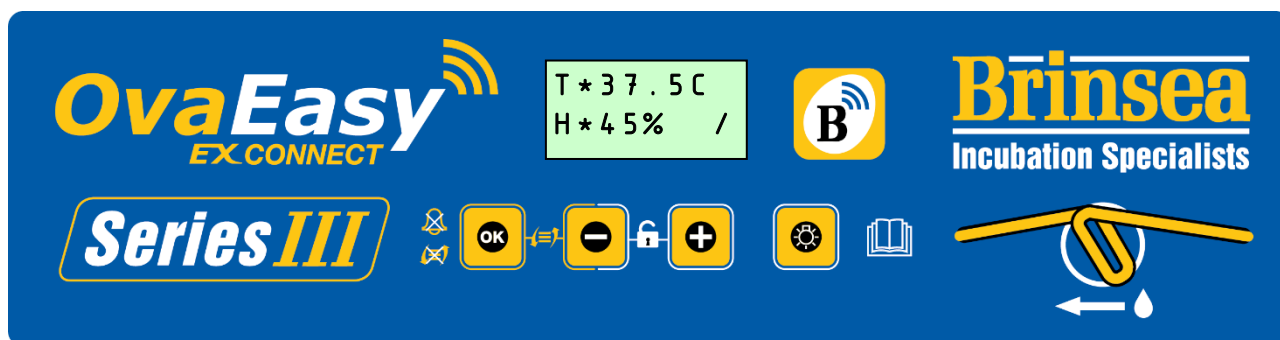

The OvaEasy EX Connect control system utilises highly accurate, individually calibrated sensors for temperature and humidity. Be cautious of low cost analogue or digital thermometers and hygrometers when comparing them with the incubator display readings.

**NORMAL OPERATION** – Temperature, relative humidity and turn system status are continuously displayed. Turning status indicator shows if automatic turning is switched on or off.

The asterisk "\*" adjacent to the temperature reading shows when the heater power is on. When warming the asterisk will be continuously on, once warmed up the asterisk will slowly flash as the heater is pulsed to maintain the correct temperature.

When reducing the temperature setting the asterisk may go off, this is normal. During periodic incubation cooling (see section 12) the asterisk will be replaced by an arrow: "↓".

The asterisk "\*" adjacent to the humidity reading shows when the pump output is active (see section 8). The pump output will not come on until the incubator is up to operating temperature and the set humidity level is greater than the measured humidity level in the incubator.

If automatic turning is switched off "O" is shown in the corner of the display.

If automatic turning is switched on a line "/" symbol is shown revolving in the corner of the display.

**CHANGING SETTINGS** – The control menu allows the various settings to be modified and saved. All settings are retained in the event of a power cut.

To access the Control Menu press the + and – buttons simultaneously to unlock the display. For full details of menu settings please refer to the contents on page 3 and view the relevant sections.

**POWER LOSS DISPLAY** – If power has been interrupted due to a power cut (or when first switching on) a "P" is shown flashing on the bottom line of the display. Press OK for 2 or more seconds to clear the indicator. If the reason for the power loss is not known check the power cable connections are secure.

Once the "P" indicator has been cleared, it is advisable to candle eggs a number of times to check for losses.

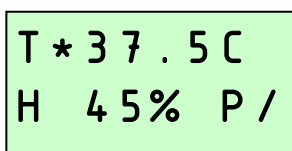

**HIGH TEMPERATURE ALARM DISPLAY** – If the temperature inside the incubator goes up by more than the figure in the ALARM HI screen, the alarm will sound immediately and “H” will be displayed. Press OK to silence the alarm for 30 minutes.

If the high temperature problem rectifies itself the “H” remains on the display to show this has happened. Press OK to clear the indicator. Check the incubator is not (and has not been) in direct sunlight or too near a heat source such as a room heater. It is advisable to candle eggs a number of times after this event to check for losses.

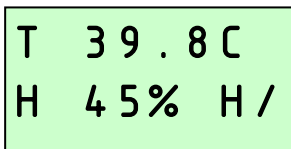

A rectangular display with a light green background and a black border. The text is in a monospaced font. The top line shows 'T 39.8 C' and the bottom line shows 'H 45% H/'.

**LOW TEMPERATURE ALARM DISPLAY** – If the temperature inside the incubator goes down by more than the figure in the ALARM LO screen, after 60 minutes “L” will be displayed and the alarm will sound. Press OK to silence the alarm for 30 minutes.

If the low temperature problem rectifies itself the “L” remains on the display to show this has happened. Press OK to clear the indicator. Check the incubator is not (and has not been) in a cold draught or that the room temperature has dropped significantly. It is advisable to candle eggs a number of times after this event to check for losses.

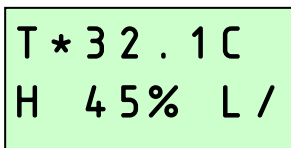

A rectangular display with a light green background and a black border. The text is in a monospaced font. The top line shows 'T \* 32.1 C' and the bottom line shows 'H 45% L/'.

**LOW ROOM TEMPERATURE ALARM** – If the calculated room temperature remains too low for optimum results for more than 1 hour a warning is displayed “-RM” and an alarm will sound. Press OK to silence the alarm for 30 minutes.

If the low temperature problem rectifies itself the “-RM” remains on the display to show this has happened. Press OK to clear the indicator. Check the incubator is not (and has not been) in a cold draught or that the room temperature has dropped significantly. It is advisable to candle eggs a number of times after this event to check for losses.

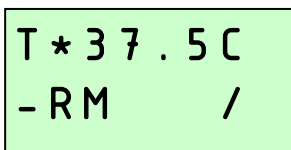

A rectangular display with a light green background and a black border. The text is in a monospaced font. The top line shows 'T \* 37.5 C' and the bottom line shows '- RM /'.

**HIGH ROOM TEMPERATURE ALARM** – If the calculated room temperature remains too high for optimum results for more than 1 hour a warning is displayed “+RM” and an alarm will sound. Press OK to silence the alarm for 30 minutes.

If the high temperature problem rectifies itself the “+RM” remains on the display to show this has happened. Press OK to clear the indicator. Check the incubator is not (and has not been) in direct sunlight or too near a heat source such as a room heater. The eggs themselves create significant metabolic heating at later stages of incubation and may contribute to this if room temperature is high, it is advisable to candle eggs a number of times after this event to check for losses.

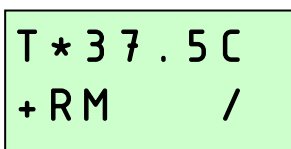

A rectangular display with a light green background and a black border. The text is in a monospaced font. The top line shows 'T \* 37.5 C' and the bottom line shows '+ RM /'.

**LOW HUMIDITY ALARM DISPLAY** – If the measured humidity inside the incubator goes down by more than the figure in the RH ALARM screen, after 2 hours an alarm will sound and the humidity display will flash. Press OK to silence the alarm for 30 minutes.

If the low humidity rectifies itself the humidity display remains flashing to show this has happened. Press OK to clear the indicator.

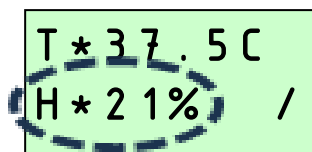

### **AUTOMATIC SHELF LEVELLING**

TO PREVENT THE RISK OF POSSIBLE INJURY OR DAMAGE TO THE MECHANISM NEVER INITIATE A TURN WITH THE DOOR OPEN. THE MOTOR WILL BE SWITCHED OFF IF THE DOOR IS NOT FULLY CLOSED AND A FAULT MESSAGE MAY BE SET.

AN ALARM SOUNDS AT THE START OF EACH TURN TO WARN THE OPERATOR. THE SHELVES MAY BE STOPPED BY PRESSING ANY BUTTON ONCE.

- **To make the shelves level for a short time when loading or inspecting eggs:**

Automatic turning must be set to **ON** in the Control Menu.

Press the OK and – buttons at the same time. The control system starts the shelves turning and stops them when they are approximately level. The automatic turning system will be left in “pause” mode.

A button must be pressed to resume automatic turning again. The shelves will move to the side position and normal automatic turning will be restarted. If it is not restarted within 30 minutes an alarm sounds to remind the operator.

If a button is pressed at any time while the shelves are turning the motor is stopped and the system will be left in “pause” mode. A button must be pressed to resume automatic turning again. If it is not restarted within 30 minutes an alarm sounds to remind the operator.

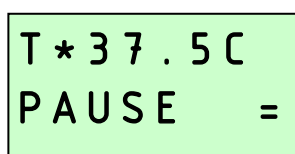

- **To make the shelves level for a long time (e.g. when hatching eggs):**

Automatic turning must be set to **OFF** in the Main Menu.

Press the OK and – buttons at the same time. The control system starts the shelves turning and stops them when they are approximately level. No further action is taken until automatic turning is switched back on in the main menu.

If a button is pressed at any time while the shelves are turning the motor is stopped and the system will be left in “pause” mode. A button must be pressed to resume turning again. If it is not restarted within 30 minutes an alarm sounds to remind the operator.

**TURN SYSTEM FAULT ALARM** - If the shelves become jammed by debris or incorrectly loaded trays the motor is switched off and an alarm sounds. The display shows "FAULT". Automatic turning is also temporarily set to **OFF** in the Main Menu to prevent the turn restarting. Always check trays are loaded to the back of each shelf as damage may occur if the shelves are jammed by trays placed too far forward. This alarm may also be triggered if the door is not fully closed. See section 15 for more information.

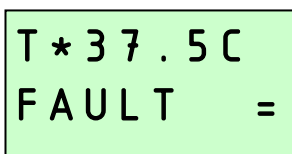

## 7. Storage of eggs

Store eggs in cool, damp conditions. Most species may be safely stored for up to 14 days before serious reductions in hatch rates are likely. Daily turning of stored eggs also helps maintain hatchability.

Cracked, mis-shaped and heavily soiled eggs should be discarded (if possible). It is not recommended that eggs for incubation are washed as this will remove the outer cuticle from the egg as well as the dirt and may leave the egg at greater risk from bacterial contamination. However soiled eggs can add contaminants that are damaging to growing embryos in the egg, so if cleaning is the only option a specialist egg wash solution should be used following the manufacturer's instructions.

## 8. Temperature

**Stable and correct temperature is essential for good results. Adjust with care.**

Note: your incubator may not be set to the correct temperature from the factory and the following procedure must be followed before setting eggs.

As the incubator warms up and approaches its control setting the heater on asterisk "\*" will change from continuously on to flashing.

### SETTING THE TEMPERATURE



Press the - and + buttons simultaneously to unlock the Control Menu



Press OK to select the temperature screen and adjust as necessary using the + and - buttons.



Press OK to return to the Control Menu and then scroll down to SAVE. Press OK to save the changes.

When reducing temperature, the asterisk may go out while the incubator cools – this is normal. Adjust temperature with care – small differences have large effects on hatching performance.

## CHANGING TO FAHRENHEIT



Press the - and + buttons simultaneously to unlock the Control Menu.



Scroll to the C/F option and press OK to select the C/F display screen.



Press the + button to select °F or the – button to select °C.



Press OK to return to the Control Menu and then scroll down to SAVE. Press OK to save the changes.

	Recommended temperatures:		Typical incubation period:
<b>Hens:</b>	37.4 – 37.6°C	99.3 – 99.6°F	21 days
<b>Pheasant:</b>	37.6 – 37.8°C	99.6 - 100°F	23-27 days
<b>Quail:</b>	37.6 – 37.8°C	99.6 - 100°F	16-23 days
<b>Ducks:</b>	37.4 – 37.6°C	99.3 – 99.6°F	28 days
<b>Geese:</b>	37.4 – 37.6°C	99.3 – 99.6°F	28-32 days

Developing embryos are fairly tolerant of short-term temperature drops and the user need not be concerned about cooling that occurs when inspecting eggs. Temperatures above ideal can quickly have a serious detrimental effect on hatch rates and must be avoided.

OvaEasy Series III incubators have a built-in temperature alarm which warns of high or low incubation temperature and room temperature. See section 6 for details.

## 9. Humidity and Ventilation

Short term variations in humidity are not important. The average humidity over the incubation period needs to be near optimum to achieve the ideal weight loss. High humidity for the day or two of hatching is also important. Beware long term excessive humidity.

If the humidity level in the incubator is lower than the Set Humidity Level the pump will start to turn (sometimes brief pulses) and gradually draw water from the tank and pump it to the evaporation card in the incubator. This may take a few hours to pump through and stabilise after which the pump will run intermittently as the humidity level is controlled.

Two main factors affect incubation humidity: water evaporation within the cabinet (from eggs as well as from additional water) and levels of ventilation. The water content of the air being drawn through the incubator will also have an effect. In general, the adjustable vent should be set to its minimum to give optimum control.

There are two methods available to bird breeders to achieve correct humidity levels:

1. Monitor humidity levels and adjust to match published guidelines for different species.

Generally accepted incubation RH levels for species groups:

<b>During incubation:</b>	Poultry	40-50% RH
	Waterfowl	45-55% RH
<b>Hatching:</b>	All species	60% RH or more

2. Monitor egg weight loss which varies as a direct result of humidity and correct against published weight loss figures for the species. This is the most reliable method and is recommended – particularly where poor hatch rates are experienced or if eggs of high value are being incubated.

Eggs lose moisture through their shells, and the rate of evaporation depends on the humidity levels around the eggs and the shell porosity. During incubation eggs need to lose a fixed amount of water which corresponds to a loss in weight of around 13-16% depending on species. By weighing eggs periodically during incubation, it is possible to monitor and, if necessary, correct humidity levels to achieve the correct weight loss.

Typical ideal weight losses for species groups:

<b>Poultry</b>	<b>13%</b>
<b>Waterfowl</b>	<b>14%</b>

For more detailed information on all aspects of egg incubation including helpful advice on getting best results please visit our website at [www.brinsea.co.uk/incubationhandbook](http://www.brinsea.co.uk/incubationhandbook).

#### SETTING THE HUMIDITY LEVEL



Press the - and + buttons simultaneously to unlock the Control Menu



Scroll to the RH% option and press OK to select the RH% screen.



Adjust as necessary using the + and - button.



Press OK to return to the Control Menu and then scroll down to SAVE. Press OK to save the changes.

**The pump will not run if the incubator is significantly below the set temperature (including during periodic incubation cooling). This is to prevent the system adding too much water when the door has been opened for inspecting eggs etc.**

In all cases the humidity for hatching needs to be high. Because of the short duration involved water/weight loss will not be significantly affected. High humidity is necessary to prevent membranes drying and hardening before the hatch fully emerges. Humidity will naturally increase as the first eggs begin to hatch and internal membranes begin to dry. This is in addition to the water added by the pump.

During hatching the high humidity levels will fall dramatically when the door is opened and will take some time to build up. Resist the temptation to open the door frequently – leave for at least 6 hours between inspections.

The control system may be set to control between 20 and 80% RH. In practice the minimum and maximum levels of humidity achievable in an incubator depend upon several factors including the ambient conditions in the incubation room. You may need to allow 24 hours for humidity to fully stabilise after making changes.

If you cannot achieve the relative humidity level required consider these notes:

#### Humidity will not go low enough

- The humidity control system can only increase humidity, not actively reduce it. Open the vent fully to help.
- A lower limit will be determined by the moisture content of the ambient air, particularly in warm humid conditions. This can only be countered by dehumidification of the room air outside the incubator with a proprietary dehumidifier but is rarely a problem in practice.

#### Humidity will not go high enough

- Close the vent to its minimum setting to help.
- Check that water is reaching the incubator when the pump runs – if not check the whole length of the tubing for kinks and check that the tubing around the pump has not become permanently flattened. If it has, try stretching it gently to open it. If that fails replace the pump tube (see page 7). Silicone tubing is very flexible but can be damaged by sharp finger nails. A tiny perforation on the suction side of the pump will let in air and prevent the pump drawing water.
- The tubing around the pump must be replaced periodically, typically every three months but this varies with use. See page 7 for details.

#### Condensation

- Under certain conditions it is possible that condensation may form on the inner walls. The presence of water gathering at the base of the incubator or inside the door does not affect the performance of your incubator and does not pose an electrical hazard. It is often an indication that room temperature is falling too low at night.

#### Adjustable ventilation

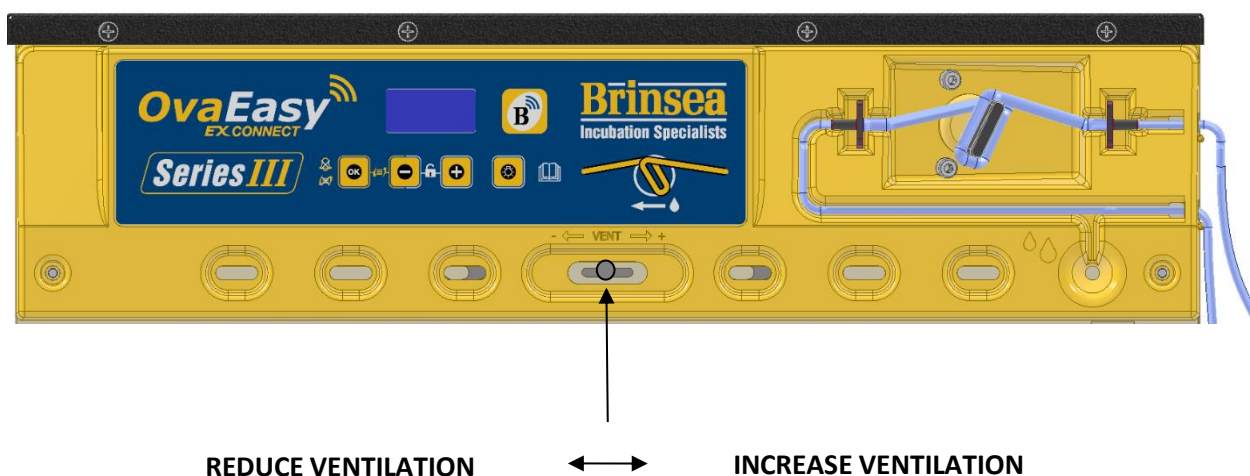

In general, the adjustable vent should be set to its minimum to give optimum control of humidity but may be opened to reduce excessive humidity after hatching.

## 10. Egg Turning

### SETTING THE TURNING OPTIONS



Press the - and + buttons simultaneously to unlock the Control Menu



Scroll to the Turn 0/1 option and press OK to select the turning mode screen.



Select ON or OFF as required using the + and - buttons.



Press OK to return to the Control Menu. The Turn Interval option will now be displayed. Press OK to select the turn interval screen and use the + and - buttons to set the delay between turns in minutes as required.



Press OK to return to the Control Menu and then scroll down to SAVE. Press OK to save the changes.

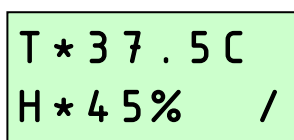

Automatic turning is ON

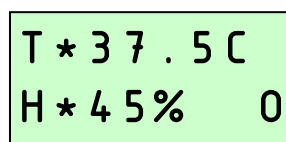

Automatic turning is OFF

### AUTOMATIC SHELF LEVELLING (FOR LOADING OR HATCHING)

TO PREVENT THE RISK OF POSSIBLE INJURY OR DAMAGE TO THE MECHANISM NEVER INITIATE A TURN WITH THE DOOR OPEN. THE MOTOR WILL BE SWITCHED OFF IF THE DOOR IS NOT FULLY CLOSED AND A FAULT MESSAGE MAY BE SET.

AN ALARM SOUNDS AT THE START OF EACH TURN TO WARN THE OPERATOR. THE SHELVES MAY BE STOPPED BY PRESSING ANY BUTTON ONCE.

- **To make the shelves level for a short time when loading or inspecting eggs:**

Automatic turning must be set to **ON** in the Control Menu.

Press the OK and – buttons at the same time. The control system starts the shelves turning and stops them when they are approximately level. The automatic turning system will be left in “pause” mode.

A button must be pressed to resume automatic turning again. The shelves will move to the side position and normal automatic turning will be restarted. If it is not restarted within 30 minutes an alarm sounds to remind the operator.

If a button is pressed at any time while the shelves are turning the motor is stopped and the system will be left in “pause” mode. A button must be pressed to resume automatic turning again. If it is not restarted within 30 minutes an alarm sounds to remind the operator.

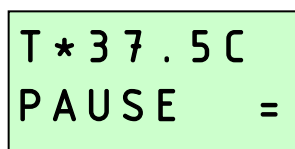

- **To make the shelves level for a long time (e.g. when hatching eggs):**

Automatic turning must be set to **OFF** in the Main Menu.

Press the OK and – buttons at the same time. The control system starts the shelves turning and stops them when they are approximately level. No further action is taken until automatic turning is switched back on in the main menu.

If a button is pressed at any time while the shelves are turning the motor is stopped and the system will be left in “pause” mode. A button must be pressed to resume turning again. If it is not restarted within 30 minutes an alarm sounds to remind the operator.

**TURN SYSTEM FAULT ALARM** - If the shelves become jammed by debris or incorrectly loaded trays the motor is switched off and an alarm sounds. The display shows "FAULT". Automatic turning is also temporarily set to **OFF** in the Main Menu to prevent the turn restarting. Always check trays are loaded to the back of each shelf as damage may occur if the shelves are jammed by trays placed too far forward. This alarm may also be triggered if the door is not fully closed. See section 15 for more information.

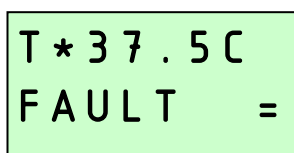

## 11. Egg Setting

Before setting eggs ensure that the incubator has been run for several hours and has stabilised at the correct temperature. Set the shelves level for loading (see section 10).

Use the standard egg “flats” or Universal Egg Trays as purchased with the incubator to set the eggs on the setting shelves. Load the shelves evenly to avoid overloading the turning system. Eggs should be evenly distributed over each flat or tray to ensure the shelves are balanced. Note that some egg trays are narrower than others and may slide from side to side on the shelves. This is not something to be concerned about.

Eggs may be set on end (or at an angle) provided the large end of the egg is upwards. Eggs rolling through a few degrees as the incubator turns are not in danger.

**Ensure that nothing can restrict the movement of the trays or setting shelves. This may damage the turning mechanism and invalidate the guaranty. Load the setting shelves evenly to help prevent imbalanced operation. ENSURE TRAYS ARE PUSHED TO THE BACK OF EACH SHELF.**

Once the egg trays have been placed on the shelves close the door.

Re-start the turning (see section 10).

Once the eggs have been set the temperature must not be adjusted for 24 hours to allow the eggs to warm. Check the water level every 3 days or so and temperature daily. Candle the eggs after 1/3rd of the incubation period has elapsed to reject clear, infertile eggs. Remember to stop the turning 2 days before the eggs are due to hatch and to fit hatching tray covers.

## 12. Periodic Incubation Cooling

### BACKGROUND INFORMATION ON PERIODIC COOLING

The cooling function is not essential. It's an optional feature that may be adjusted for breeders wishing to experiment. The factory default is set to "cooling OFF". **Do not use before day 7 of incubation or whilst hatching.**

The precise details of which days and what cooling period each day should be used for best effect are not known. Brinsea have assessed the available research and suggest that poultry, waterfowl and game bird eggs have a 30 minute daily cooling period from day 7 through to 2 days before eggs are due to hatch (the same point that automatic turning would normally be stopped).

COOLING IS NOT RECOMMENDED FOR PARROTS AND BIRDS OF PREY BECAUSE THE RESULTS OF COOLING HAVEN'T YET BEEN ESTABLISHED. For further details please visit the Brinsea website at [www.brinsea.co.uk/cooling](http://www.brinsea.co.uk/cooling)

### HOW IT WORKS WITH YOUR INCUBATOR

The periodic cooling feature turns the incubator's heater and low temperature alarm off for a selectable period but keeps the fans running. After the cooling period is complete the incubator reverts to normal temperature and the alarm is automatically reset.

Each cooling period starts at approximately the same time each day (24 hours between start times).

During the cooling period the heater asterisk goes off and an arrow "↓" is displayed. When the cooling period ends the asterisk is shown and the incubator warms to incubation temperature. The time taken to return to incubation temperature depends on the room temperature and may take 30 or more minutes. The humidity pump will not run during periodic cooling; humidity levels will rise as the air cools.

### SETTING THE COOLING PERIOD



Press the - and + buttons simultaneously to unlock the Control Menu



Scroll to the Cooling 0/1 option and press OK to select the cooling mode screen.



Select ON or OFF as required using the + and - buttons.



Press OK to return to the Control Menu. The Cooling Period option will now be displayed. Press OK to select the Cooling Period screen and use the + and - buttons to set the length of cooling period as required.



Press OK to return to the Control Menu and then scroll down to SAVE. Press OK to save the changes.

## 13. Hatching

Turn the automatic turning system off and set the shelves level (see section 10 for details).

Hatching humidity levels need to be high (see section 9 for details). The ventilation control may be set at minimum to help increase humidity and opened again once the eggs have hatched to help dry the chicks. When most eggs have hatched (12 to 48 hours) it may be recommended to remove the hatchlings to a brooder.

During hatching the high humidity levels will fall dramatically when the door is opened and will take some time to build up. Resist the temptation to open the door frequently – leave for at least 6 hours between inspections.

To assemble the hatching tray(s) remove the dividers from an OvaEasy universal tray and place a white plastic peg in each of the four corner sockets. The wide end of the peg should make a push fit into the socket. Another universal tray may then be placed upside-down over the narrow end of the pegs to form a secure lid over the hatching eggs. When the lid is removed the pegs will stay fixed in the bottom tray.

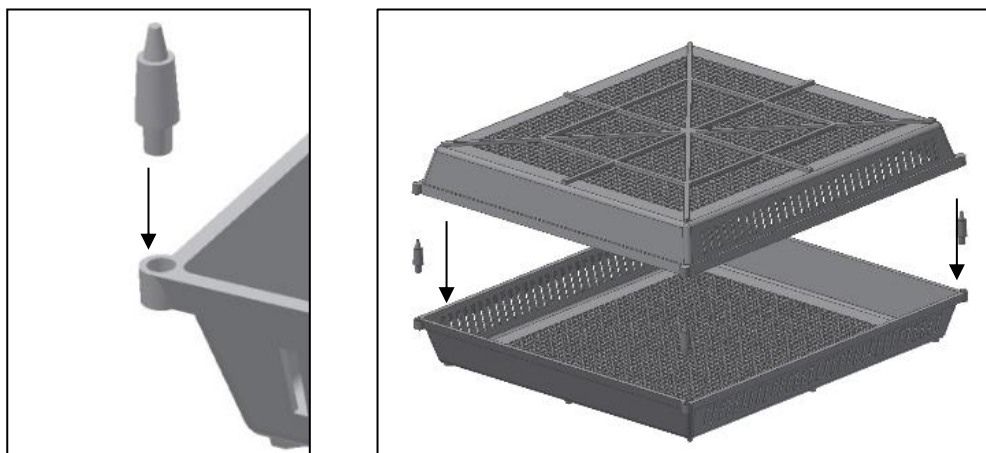

## 14. Cleaning Up

**IMPORTANT:**

**DISCONNECT THE INCUBATOR FROM THE MAINS POWER SUPPLY DURING CLEANING.**

**ENSURE THAT ALL ELECTRICAL PARTS ARE KEPT DRY.**

**NEVER WASH THE TRAYS, INSULATED PANELS, FASCIA OR EVAPORATION TRAY PARTS WITH LIQUIDS OVER 50°C (120°F). DO NOT USE A DISHWASHER TO CLEAN THESE PARTS.**

Following each hatch in the Cabinet Incubator remove and wash the egg trays in Incubation Disinfectant Solution. Wipe all other internal surfaces with a soft cloth soaked in the solution. Ensure that the instructions supplied with the fluid are followed. Dust and fluff may be removed from the fan guard area with a soft brush.

If a separate hatcher is used the procedure above should still be followed every two months.

The exterior of the incubator may be cleaned with a damp cloth. Avoid allowing any moisture to get inside the top electrical housing or electrical connector at rear.

Always clean the incubator before storage and ensure that the unit is totally dry inside and out.

### REMOVING THE SHELVES FOR DEEP CLEANING

Ensure the shelves are set level and disconnect power supply from the incubator.

Start with the top shelf.

Pull the silicone fastener piece from the link bar stud.

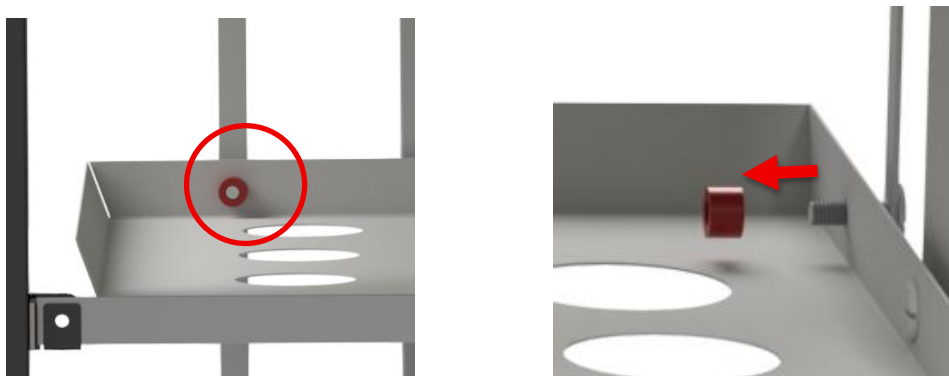

Lift both ends of the shelf support beam up out of their brackets.

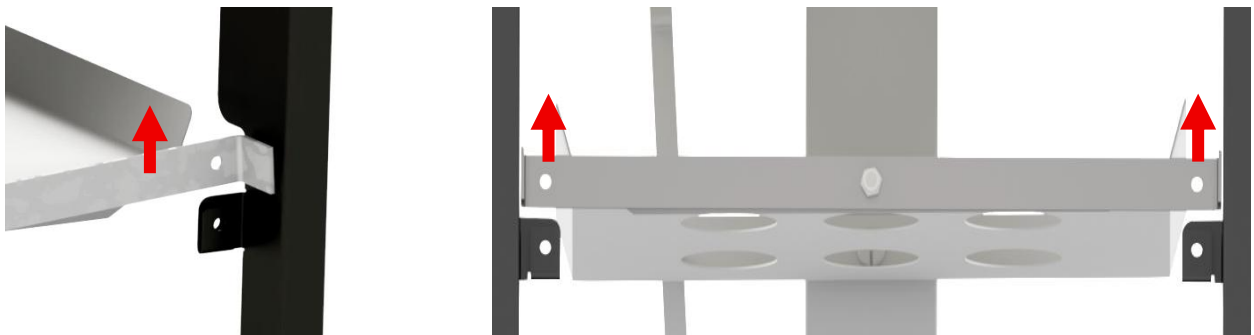

Lift the shelf and its support beam clear of the brackets and out of the incubator.

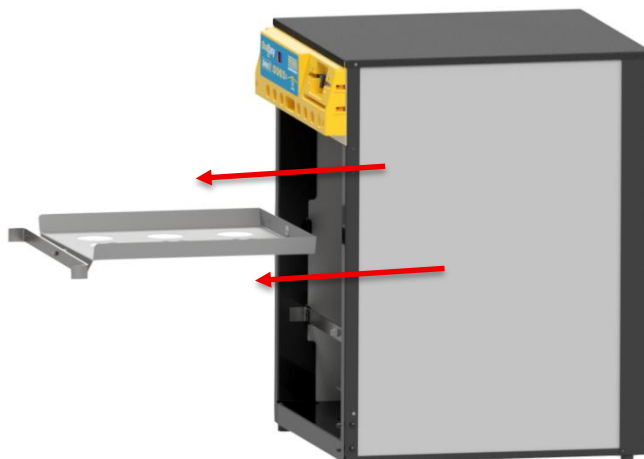

Repeat this process for the next shelf.

**Refitting the shelves is reverse of the removal. Note the following:**

Start with the bottom shelf, locate the rear stud of the shelf into the corresponding hole in the rear column of the incubator and then lower the support beam into the brackets.

Refit the bottom stud of link bar through the hole in the left-hand side of the shelf and secure it with the silicone fastener before fitting the top shelf.

**15. Trouble-shooting and Calibration**

Under certain conditions it is possible that condensation may form on the inner walls. The presence of water gathering at the base of the incubator or inside the door does not affect the performance of your incubator and does not pose an electrical hazard. It is often an indication that room temperature is falling too low at night.

In case of failure first check that the mains power supply is working and that the mains cable connector is fully engaged in the socket on the rear panel. The digital control system may be reset to the original factory defaults by connecting the power supply while holding the OK button.

Error messages:

**FAULT** – The digital control system monitors how long it takes for the shelves to turn to the end position switch. If the signal from the switch is late (or not sent at all) the control stops the turning system and displays **FAULT**. This may be caused by:

- Debris or incorrectly loaded trays. Clear any debris. Arrange eggs evenly (balanced from side to side) and make sure the trays are pushed fully back. Switch the turning system back on (Section 9) and check the turning function.
- Door not closed. Make sure the door is fully closed, switch the turning system back on (Section 9) and check the turning function.

**SENSOR ERROR** – The control system communicates to the temperature and humidity sensor with a digital signal that under normal conditions is highly tolerant of external electrical disturbances. However, if the signal becomes interrupted and cannot be recovered automatically the control displays **SENSOR ERROR**. This may be caused by:

- Strong electrical interference perhaps from a faulty appliance or lights. Restart the incubator and try a different power socket or a “surge protector” type socket adaptor.

If the problem persists contact your distributor or Brinsea Products Service Dept.

The digital temperature and humidity display is individually calibrated during manufacture but may be re-calibrated if required. In the unlikely event that your hatching success makes you doubt the temperature or humidity calibration of your machine please contact your distributor or Brinsea directly at [sales@brinsea.co.uk](mailto:sales@brinsea.co.uk) for further information and advice.

**BE CAUTIOUS OF LOW COST ANALOGUE OR DIGITAL THERMOMETERS AND HYGROMETERS.**

**BRINSEA PRODUCTS LTD USES SOPHISTICATED EQUIPMENT TRACEABLE TO INTERNATIONAL REFERENCE STANDARDS.**

## 16. Specification

### Maximum Approximate Setting Capacities (includes use of special inserts):

Egg size	Approximate Capacity
Quail	248 (496 if a separate hatcher is used)
Pheasant	118
Hen	96
Duck	60
Goose	30

### Dimensions:

620 x 420 x 480mm (24.5" x 16.5" x 19") H x W x D

### Weight:

16Kg (35lbs)

### Power Consumption:

Maximum	200 Watts
(typical average)	80 Watts

**Electrical Supply:** 230v 50Hz or 110V 60Hz (as ordered)

Radio frequency band: 2.4GHz Wi-Fi (Channels 1 – 11 only)  
Maximum effective isotropic radiated power 2412 – 2462 MHz 13.66dBm



Used electrical and electronic products should not be mixed with general household waste. For proper treatment, recovery and recycling, please take this product to a designated collection point where it will be accepted free of charge.

Please contact your local authority for further details of your nearest designated collection point.

Disposing of this product correctly will help save valuable resources and prevent any potential negative effects on human health and the environment, which could otherwise arise from inappropriate waste handling.

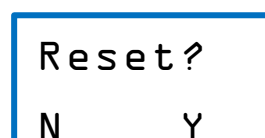

Your home Wi-Fi ID and password may be cleared from the incubator by holding the OK button and connecting the power lead. The control panel on the incubator will show "Reset?" when ready to clear the data. Press the + button (Y) to reset all factory defaults and clear the Wi-Fi details.

To remove your personal data from the app and server, tap Delete Account in the app Options page.

Brinsea Products Ltd, 32-33 Buckingham Road, Weston Industrial Estate,  
Weston-super-Mare, N. Somerset, BS24 9BG

Tel: +44 (0) 345 226 0120

e-mail: [support@brinsea.co.uk](mailto:support@brinsea.co.uk), website: [www.brinsea.co.uk](http://www.brinsea.co.uk)

## **Declaration of Conformity**

**We:** BRINSEA PRODUCTS LTD.  
32-33 Buckingham Road  
Weston Industrial Estate  
Weston-super-Mare  
North Somerset  
BS24 9BG

Declare under our sole responsibility the products:

### **Egg Incubators:**

**Ova-Easy 100 EX Connect Series III (Serial numbers MJ1044x/xxxxxxxxx)**

to which this declaration relates are in conformity with the following UK regulations:

### **Radio Equipment Regulations 2017**

### **The Restriction of the Use of Certain Hazardous Substances in Electrical and Electronic Equipment Regulations 2012**

The relevant sections of the following Standards have been used:

**BS EN 60335-1:2012+A15:2021**  
**BS EN 60335-2-71:2003+A1:2007**  
**BS EN 55014-1:2017+A11:2020**  
**BS EN 55014-2:2015**  
**ETSI EN 300 328 V2.2.2**  
**BS EN 62479:2010**  
**EN 18031-1:2024**  
**BS EN 63000:2018**

The technical documentation for the products is available from the above address.

**Authorised Representative:** Ian Pearce, Managing Director

**Signature:**

**Date of Issue:** 31 March 2026

**Place of Issue:** 32-33 Buckingham Road, Weston Industrial Estate, Weston-super-Mare, North Somerset, BS24 9BG, United Kingdom.



In accordance with European Parliament and Council  
Decision No 768/2008/EC Annex III

*1. Radio equipment model / product:*

Product: Egg incubator  
Model: OvaEasy 100 EX Connect Series III (Serial Numbers MJ1044x/xxxxxxxxx)

*2. Manufacturer:*

Name: Brinsea Products Ltd.  
Address: 32-33 Buckingham Road, Weston Industrial Estate,  
Weston-super-Mare, BS24 9BG, England

*Authorised Representative:*

Name: Authorised Rep Compliance Ltd.  
Address: Ground Floor, 71 Lower Baggot Street, Dublin, D02 P593, Ireland

*3. This declaration is issued under the sole responsibility of the manufacturer.*

*4. Object of the declaration:*

Product: OvaEasy 100 EX Connect Series III egg incubators  
Specification: 220-240V, 50Hz, 200W, capacity 96 eggs.

*5. The object of the declaration described above is in conformity with the relevant EU harmonisation legislation:*

2014/53/EU Radio Equipment Directive  
2011/65/EU Restriction on the use of certain hazardous substances (RoHS)

*6. References to the relevant harmonised standards used or references to the other technical specifications in relation to which conformity is declared:*

EN 60335-1:2012+A15:2021  
EN 60335-2-71:2003+A1:2007  
EN 55014-1:2017+A11:2020  
EN 55014-2:2015  
ETSI EN 300 328 V2.2.2  
EN 62479:2010  
EN 18031-1:2024  
EN IEC 63000:2018

*7. The technical documentation for the product is available from the authorised representative at the address above.*

Signed for and on behalf of: Brinsea Products Ltd.

Place of issue: Weston-super-Mare

Date of issue: 31 March 2026

Name: Ian Pearce

Function: Managing Director

Signature:

# **Statement of Compliance**

Product:

## **Egg Incubators:**

**OvaEasy 100 EX Connect Series III (Serial numbers MJ1044x/xxxxxxxxxx)**  
**OvaEasy 190 EX Connect Series III (Serial numbers MJ1944x/xxxxxxxxxx)**  
**OvaEasy 380 EX Connect Series III (Serial numbers MJ3844x/xxxxxxxxxx)**  
**OvaEasy 580 EX Connect Series III (Serial numbers MJ5844x/xxxxxxxxxx)**  
**OvaEasy Hatcher EX Connect Series III (Serial numbers MJ4944x/xxxxxxxxxx)**

Name and address of manufacturer:

BRINSEA PRODUCTS LTD.  
32-33 Buckingham Road  
Weston Industrial Estate  
Weston-super-Mare  
North Somerset  
BS24 9BG

This declaration of compliance is prepared by the manufacturer of this product.

We, the manufacturer, declare that in our opinion we have complied with:

**The Product Security and Telecommunications Infrastructure (Security Requirements for Relevant Connectable Products) Regulations 2023 – Schedule 2**

The relevant sections of the following Standards have been used:

**ETSI EN 303 645 V2.1.1 (issued 2020-06) (provision 5.1-1, 5.1-2, 5.2-1, 5.3-13)**

The defined support period for the product is one year.

## **Signed for and on behalf of the manufacturer:**

**Name:** Ian Pearce,

**Function:** Managing Director

**Signature:**

**Date of Issue:** 31 March 2026

**Place of Issue:** 32-33 Buckingham Road, Weston Industrial Estate, Weston-super-Mare, North Somerset, BS24 9BG, United Kingdom.