

OvaEasy^{EX CONNECT} HATCHER

Series III

Brinsea
Incubation Specialists



Authorised Representative:
Authorised Rep Compliance Ltd.
Ground Floor, 71 Lower Baggot
Street, Dublin, D02 P593, Ireland
www.arccompliance.com



Read the instructions before use!

Damaged appliances shall not be used.

The appliance and its supply cord must be placed in an indoor area not subject to splashes of water or wet conditions and protected from or out of reach of animals.

Repairs shall be carried out only by a suitably qualified person.

This appliance shall not be used, cleaned or maintained by children or persons with reduced physical, sensory or mental capabilities or lack of experience and knowledge without supervision. Children shall not play with the appliance.

Disconnect the hatcher from the mains power supply during cleaning. Ensure that all electrical parts are kept dry.

Record your appliance serial number here: _____

Please read these instructions carefully before setting up your hatcher to achieve best results and keep these instructions safe for future reference.

This document includes recommended procedures for successful hatching but incubation involves the control and manipulation of a large number of factors and in certain circumstances different procedures may be necessary.

For more detailed information on all aspects of egg incubation including helpful advice on getting best results please visit our website at www.brinsea.co.uk.

Your hatcher is designed to allow the user to vary the incubation conditions to suit a wide range of species in different ambient conditions and the specific set-up for every situation is beyond the scope of these instructions.

For more information on incubation and hatching please download our FREE Incubation Handbook: www.brinsea.co.uk/incubationhandbook

To register your new Brinsea product please visit www.brinsea.co.uk within 30 days of purchase and follow the link on the home page to qualify for your free 3 year guarantee. Sign up for the Brinsea Newsletter to receive the latest news and information.

Contents

| Section | Subject | Page |
|----------------|------------------------------------|-------------|
| 1 | Unpacking | 4 |
| 2 | Location and Installation | 4 |
| 3 | Setting Up the Humidity Pump | 5 |
| 4 | The Brinsea Connect App | 8 |
| 5 | Quick Reference | 9 |
| 6 | Digital Control System | 11 |
| 7 | Temperature | 13 |
| 8 | Humidity, Ventilation and Hatching | 14 |
| 9 | Cleaning up | 16 |
| 10 | Trouble-shooting and Calibration | 16 |
| 11 | Specifications | 17 |

Fig. 1 Functional Features of the OvaEasy EX Connect Series III Cabinet Hatcher

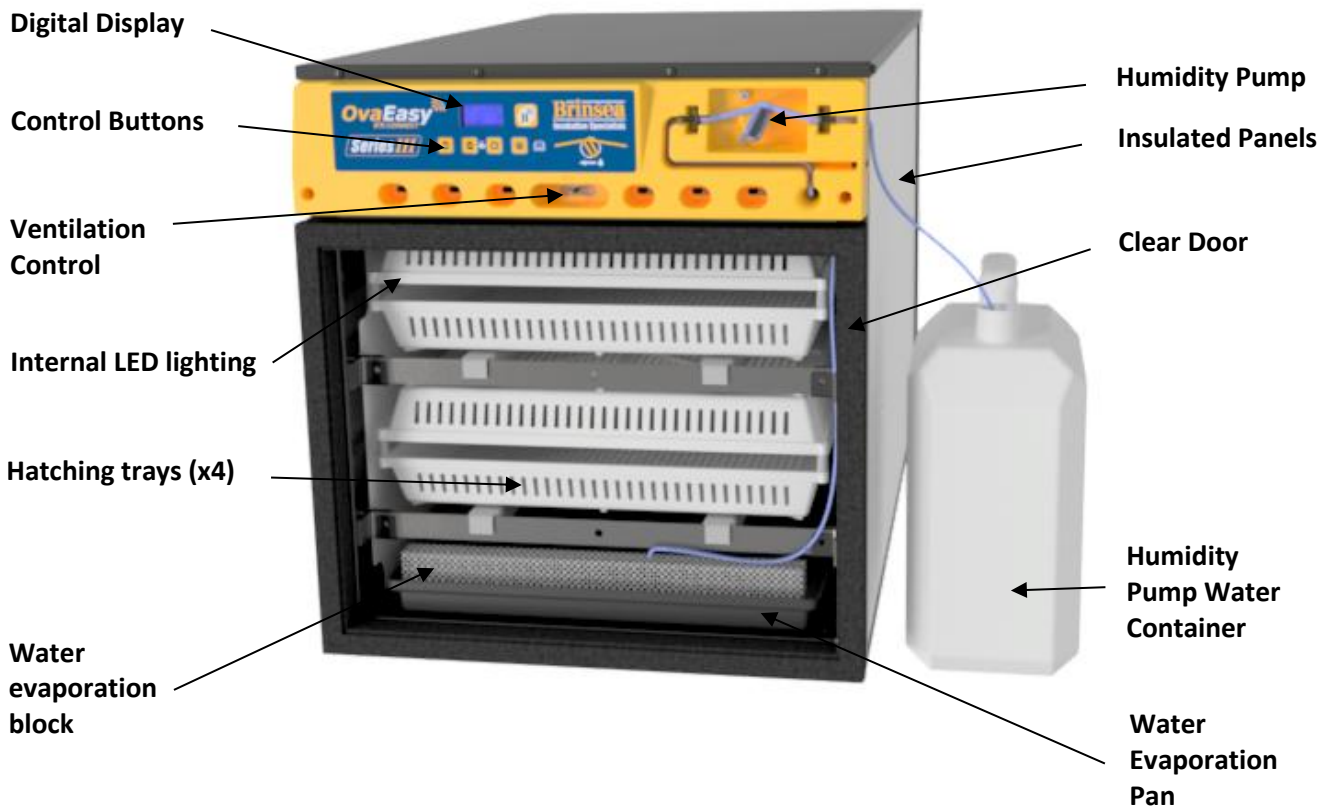

1. Unpacking

Your hatcher has been supplied in protective packaging. Please remove all tape, strapping and packing from the hatcher parts. Retain the carton and packing materials to enable the unit to be repacked. Please check that parts are all present and undamaged. Damaged appliances shall not be used.

Check that the electrical supply matches the machine's requirements (marked on the technical label on the outside of the box and on the top cover of the Hatcher). The power cord set must be an appropriately rated and approved cord-set in accordance with the regulations of the country it is used in.

Carton contents:

- 1 Cabinet Incubator
- 3m Silicone Water Tubing
- 1 Water Pump Capstan
- 1 Water Pump Tube Assembly (2 connectors and fitted tube)
- 1 Rigid Water Pipe
- 1 Water Tray
- 1 Evaporating Block
- 1 Water Bottle
- 8 Universal Trays
- 8 Tray Pegs
- 2 Power Cords

2. Location and Installation

THE HATCHER MUST BE PLACED IN AN INDOOR AREA NOT SUBJECT TO SPLASHES OF WATER OR WET CONDITIONS AND OUT OF REACH OF ANIMALS AND CHILDREN.

Your hatcher will give best results in a room free from wide temperature variations and with generous ventilation – particularly if several incubators are running at the same time. Ensure that the room temperature cannot drop on a cold night. Ideally thermostatically control the room at between 20 and 25°C (68 and 77°F). Never allow the room temperature to drop below 15°C (59°F) and ensure that the hatcher cannot be exposed to direct sunlight.

Always place the hatcher upright on a flat level surface off the floor, worktop height is ideal. Ensure the surface is adequate to support the weight of the machine and contents. See weight specifications at the end of this document.

Fit the tray support brackets as shown. One end fits in the slot in the back, the other end fits over the bar at the front.



3. Setting up the humidity pump



IMPORTANT

Do not place the water container on top of the incubator or higher than the incubator. This is to prevent water siphoning through and flooding the incubator. The water container is best placed next to the incubator on the same surface.

OvaEasy EX Connect Series III incubators use a peristaltic water metering pump to automatically control the relative humidity of the air in the egg chamber. Pumped water is fed to an expanded paper evaporation block where warm air is drawn over the large surface to effectively evaporate all the water (none should collect under normal conditions).

The hatcher is supplied with a pre-assembled humidity pump tube. Cut two lengths of the 3mm silicone tubing: one to reach from the water container to the humidity pump and one to reach from the humidity pump to the evaporating block in the bottom of the hatcher. Fit the ends of this tube to the connectors on the pre-assembled humidity pump tube.

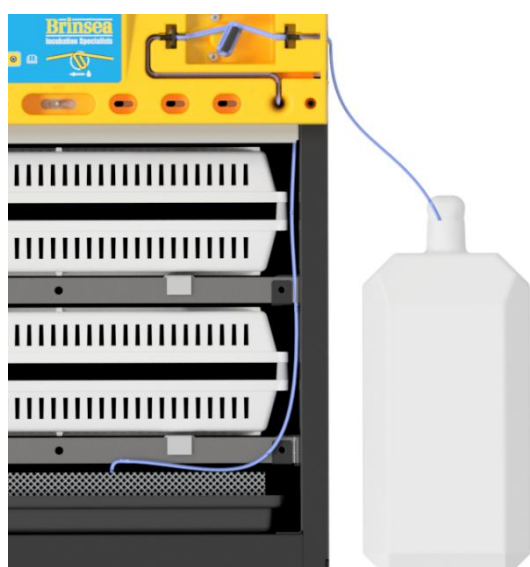
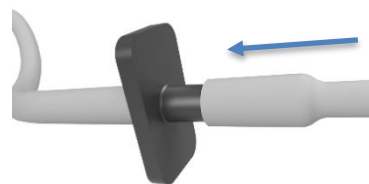

Fit the pump capstan to the pump motor. Align the slot with the shape of the motor shaft. Push the capstan fully home on the motor shaft.

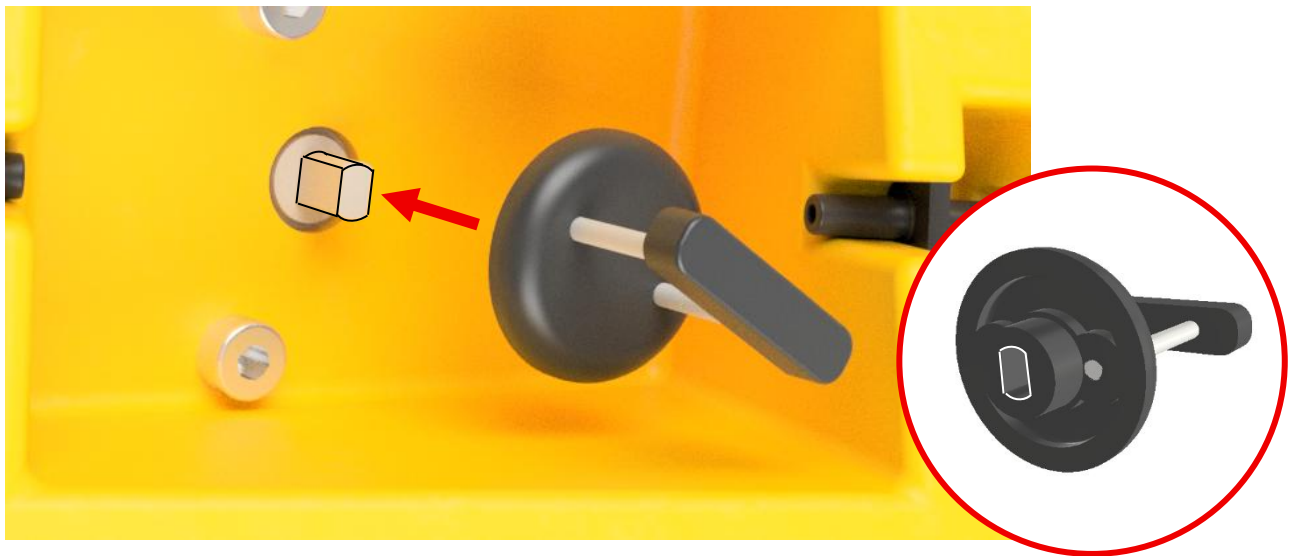

Fit the pump tube to the water pump in three steps. For clarity, only the pump tube is shown here.

1.

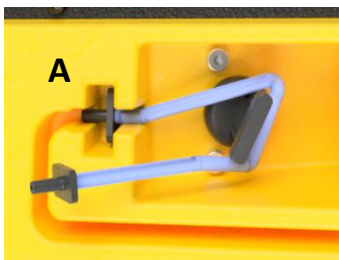

Fit the connector (fitted with the tube for the evaporating block) into the left slot 'A'. Push it fully into the slot.

2.



Wrap the pump tube clockwise around the pump capstan.

3.



Fit the connector (fitted with the tube for the water container) into the right slot 'B'. Push it fully into the slot.

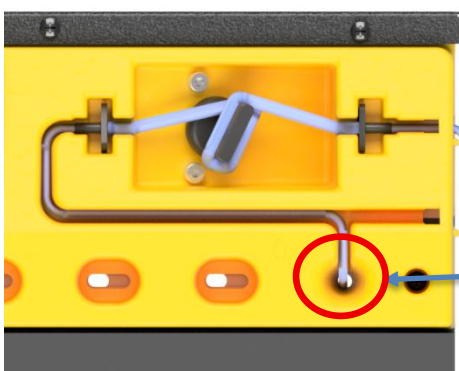

Fit the two lengths of tubing through the front panel.

To water container

To water evaporating block.

Open the door and place the water evaporation pan in the front of the hatcher. Place the Evaporation Block upright across the front of the pan (in the slot). Slide the pan back into the cabinet so that the evaporation block is at the front of the cabinet.



Fit the short, rigid plastic pipe into the end of the silicone tube going to the evaporating block by 12mm (1/2").

Insert the end of the silicone tube with the rigid pipe through the hole by the bottom door hinge.

Open the door and pull enough tube through so that its end may be pushed into the mesh of the evaporating block. As water is pumped out of the tube it will soak into the block and be evaporated by warm air flowing over the block.

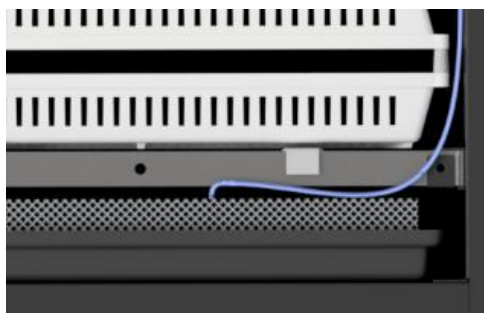

The pump is supplied with a length of the thick silicone tube to be fitted around the pump capstan. This length will wear and need periodic replacement. It can also become flattened if left unused for some time because the inside walls of the tube will stick to each other around the capstan and prevent water passing through. Either replace this length of tube with a new 115mm (4.5") length or remove it and roll it between finger and thumb to 'un-stick' it.

Please note: The inner ends of the hose connectors must have a short (8mm / 1/3") piece of the thin silicone tube fitted first and the thicker silicone tube fits over the top:

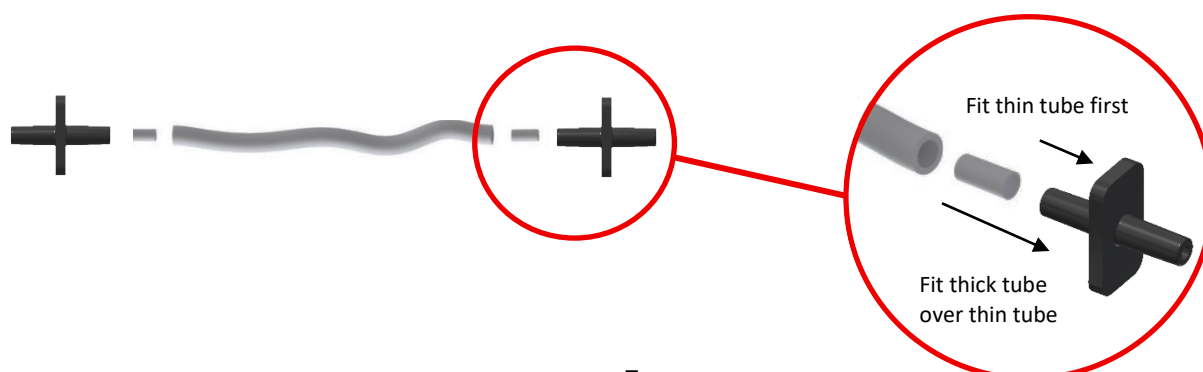

Plug the hatcher supply cable into a suitable outlet ensuring that the cable is not pulled tight. The hatcher fans will start and the LCD display will show the air temperature and humidity.

4. The Brinsea Connect App

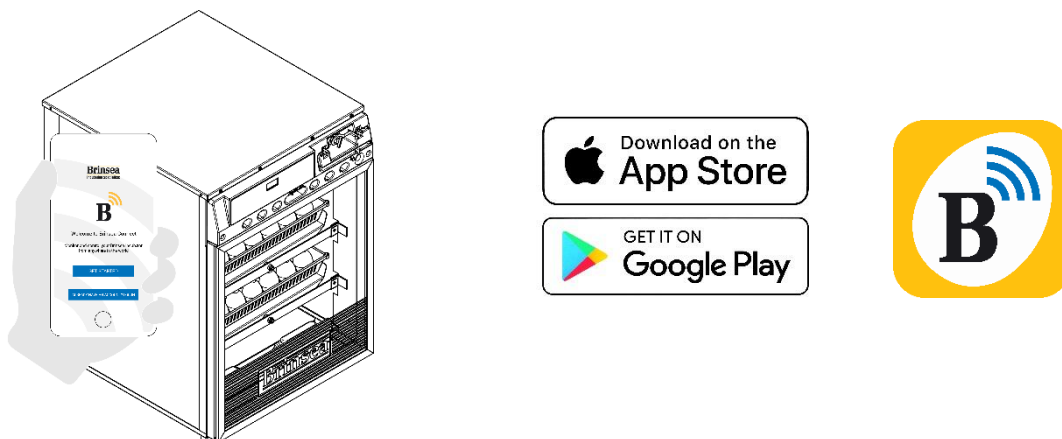

The Brinsea Connect App links to your Connect incubator and means your smartphone can:

- Monitor temperature, humidity, turning, and cooling.
- Be alerted with a phone notification to warning alarms of fluctuations in temperature, humidity and power loss.
- Change temperature, humidity, cooling and turning settings
- Future-proof your incubator/app system with future additional features as they become available.

Remote functions require connection to a Wi-Fi network. The incubator will function normally and there is no risk to incubating eggs if internet connection is lost.

INSTALL THE APP

In order to use the connected functionality of your OvaEasy EX Connect, you will need to install the Brinsea Connect App on your smartphone.

If you have an Apple device, search the App Store for the Brinsea Connect App.

If you have an Android device, search the Google Play Store for the Brinsea Connect App.

CONNECT THE INCUBATOR TO A W-FI NETWORK

Once the Brinsea Connect App is installed, follow the instructions on the app to connect your incubator to your home Wi-Fi network.

Make sure you know your home Wi-Fi network ID and password; it will be needed to connect the incubator to the network.

The app contains links to trouble-shooting tips in the Options page Help and Information section.

INSTALL ANY INCUBATOR SYSTEM UPDATES



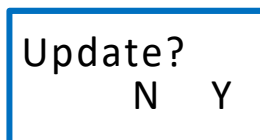

Once your incubator has been connected to the Brinsea Server and the Wi-Fi network is available, each time power is disconnected and then reconnected a check will be automatically made for any available incubator control system updates. The control panel on the incubator will show “Update?” when one is available. It is recommended to perform this check when using your incubator for the first time.



Press the + button (Y) to install. This may take several minutes. Do not unplug or turn off your incubator while it is being updated. Updates may include improvements to security or other fixes and it is recommended to install updates when available. If the internet connection is interrupted during an update the system may need to repeat the process.

5. Quick Reference (please read relevant section for detail)

This quick reference is intended to allow users to quickly set up the hatcher and learn the key features of the control system. Please read the rest of the instructions to obtain a full understanding of each feature.

| | |
|---|--|
|  | PRESS BOTH BUTTONS TO UNLOCK THE MAIN MENU |
|  | SELECT THE OPTION / RETURN TO THE MENU. |
|  | GO FORWARD ONE SCREEN / INCREASE THE VALUE / DISPLAY IN CELSIUS. |
|  | GO BACK ONE SCREEN / DECREASE THE VALUE / DISPLAY IN FAHRENHEIT. |
|  | INTERNAL LIGHTS ON / OFF. |

CONTROL MENU – QUICK REFERENCE

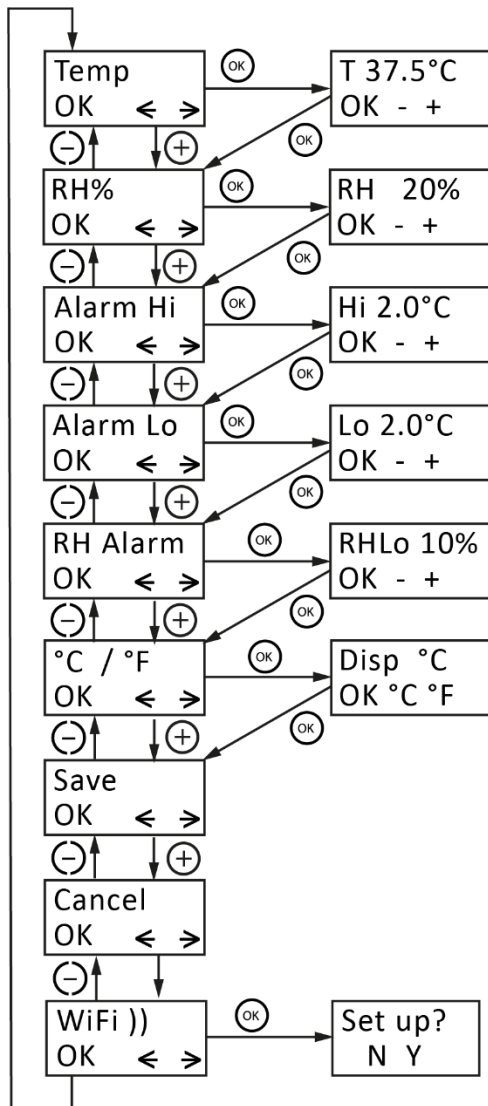

INCUBATION TEMPERATURE

Range 20.0 – 40.0°C (68.0 – 104.0°F). Default 37.5°C (99.5°F). See section 8.

RELATIVE HUMIDITY

Range 20% – 80%. Default 20%. See section 9.

HIGH TEMPERATURE ALARM

Range 1.0 – 5.0°C (1.8 – 9.0°F) above set incubation temperature. Default 2.0°C (3.6°F). See section 6.

LOW TEMPERATURE ALARM

Range 1.0 – 5.0°C (1.8 – 9.0°F) below set incubation temperature. Default 3.0°C (5.4°F). See section 6.

LOW HUMIDITY ALARM

Range 10-50%RH below set humidity. Default 10%RH. See section 6.

CELSIUS / FAHRENHEIT DISPLAY

Switches all temperature figures between °C and °F. Default °C. See section 8.

SAVE

All changes are saved. Return to normal operation screen.

CANCEL

All changes are ignored. Return to normal operation screen.

Wi-Fi

Enter Wi-Fi setup mode when using Brinsea Connect App.

6. Digital Control System

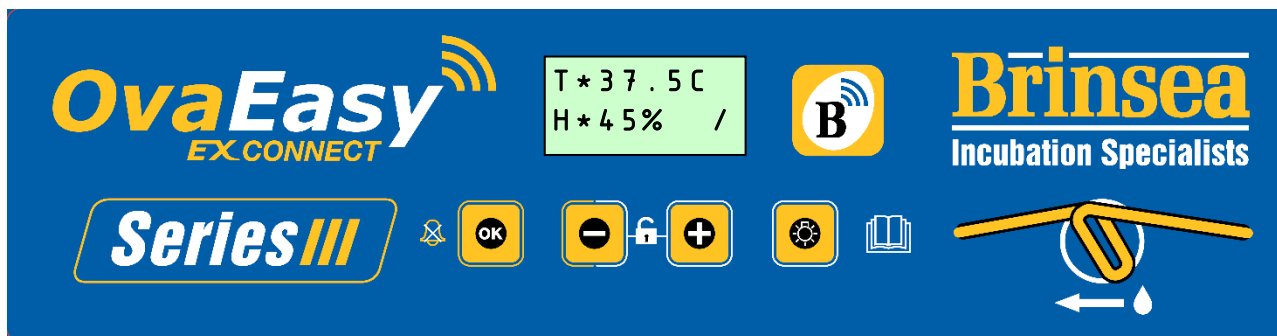

The OvaEasy EX Connect control system utilises highly accurate, individually calibrated sensors for temperature and humidity. Be cautious of low cost analogue or digital thermometers and hygrometers when comparing them with the hatcher display readings.

NORMAL OPERATION – Temperature and relative humidity are continuously displayed.

The asterisk "*" adjacent to the temperature reading shows when the heater power is on. When warming the asterisk will be continuously on, once warmed up the asterisk will slowly flash as the heater is pulsed to maintain the correct temperature.

When reducing the temperature setting the asterisk may go off, this is normal.

The asterisk "*" adjacent to the humidity reading shows when the pump output is active (see section 9). The pump output will not come on until the hatcher is up to operating temperature and the set humidity level is greater than the measured humidity level in the hatcher.

CHANGING SETTINGS – The control menu allows the various settings to be modified and saved. All settings are retained in the event of a power cut.

To access the Control Menu press the + and – buttons simultaneously to unlock the display. For full details of menu settings please refer to the contents on page 3 and view the relevant sections.

POWER LOSS DISPLAY – If power has been interrupted due to a power cut (or when first switching on) a "P" is shown flashing on the bottom line of the display. Press OK for 2 or more seconds to clear the indicator. If the reason for the power loss is not known check the power cable connections are secure.

Once the "P" indicator has been cleared, it is advisable to candle eggs a number of times to check for losses.

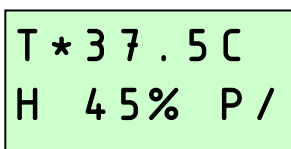

HIGH TEMPERATURE ALARM DISPLAY – If the temperature inside the hatcher goes up by more than the figure in the ALARM HI screen, the alarm will sound immediately and “H” will be displayed. Press OK to silence the alarm for 30 minutes.

If the high temperature problem rectifies itself the “H” remains on the display to show this has happened. Press OK to clear the indicator. Check the hatcher is not (and has not been) in direct sunlight or too near a heat source such as a room heater. It is advisable to candle eggs a number of times after this event to check for losses.

```
T 39.8 C
H 45% H /
```

LOW TEMPERATURE ALARM DISPLAY – If the temperature inside the hatcher goes down by more than the figure in the ALARM LO screen, after 60 minutes “L” will be displayed and the alarm will sound. Press OK to silence the alarm for 30 minutes.

If the low temperature problem rectifies itself the “L” remains on the display to show this has happened. Press OK to clear the indicator. Check the hatcher is not (and has not been) in a cold draught or that the room temperature has dropped significantly. It is advisable to candle eggs a number of times after this event to check for losses.

```
T * 32.1 C
H 45% L /
```

LOW ROOM TEMPERATURE ALARM – If the calculated room temperature remains too low for optimum results for more than 1 hour a warning is displayed “-RM” and an alarm will sound. Press OK to silence the alarm for 30 minutes.

If the low temperature problem rectifies itself the “-RM” remains on the display to show this has happened. Press OK to clear the indicator. Check the hatcher is not (and has not been) in a cold draught or that the room temperature has dropped significantly. It is advisable to candle eggs a number of times after this event to check for losses.

```
T * 37.5 C
- RM /
```

HIGH ROOM TEMPERATURE ALARM – If the calculated room temperature remains too high for optimum results for more than 1 hour a warning is displayed “+RM” and an alarm will sound. Press OK to silence the alarm for 30 minutes.

If the high temperature problem rectifies itself the “+RM” remains on the display to show this has happened. Press OK to clear the indicator. Check the hatcher is not (and has not been) in direct sunlight or too near a heat source such as a room heater. The eggs themselves create significant metabolic heating at later stages of incubation and may contribute to this if room temperature is high it is advisable to candle eggs a number of times after this event to check for losses.

```
T * 37.5 C
+ RM /
```

LOW HUMIDITY ALARM DISPLAY – If the measured humidity inside the hatcher goes down by more than the figure in the RH ALARM screen, after 2 hours an alarm will sound and the humidity display will flash. Press OK to silence the alarm for 30 minutes.

If the low humidity rectifies itself the humidity display remains flashing to show this has happened. Press OK to clear the indicator.

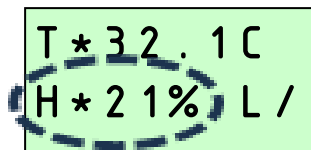

7. Temperature

Stable and correct temperature is essential for good results. Adjust with care.

Note: your hatcher may not be set to the correct temperature from the factory and the following procedure must be followed before setting eggs.

As the hatcher warms up and approaches its control setting the heater on asterisk “*” will change from continuously on to flashing.

SETTING THE TEMPERATURE



Press the - and + buttons simultaneously to unlock the Control Menu



Press OK to select the temperature screen and adjust as necessary using the + and – buttons.



Press OK to return to the Control Menu and then scroll down to SAVE. Press OK to save the changes.

When reducing temperature, the asterisk may go out while the hatcher cools – this is normal. Adjust temperature with care – small differences have large effects on hatching performance.

CHANGING TO FAHRENHEIT



Press the - and + buttons simultaneously to unlock the Control Menu.



Scroll to the C/F option and press OK to select the C/F display screen.



Press the + button to select °F or the – button to select °C.



Press OK to return to the Control Menu and then scroll down to SAVE. Press OK to save the changes.

Recommended temperatures for hatching

| | | |
|----------|---------------|---------------|
| Hens | 36.0 – 37.5°C | 96.8 – 99.5°F |
| Pheasant | 36.0 – 37.5°C | 96.8 – 99.5°F |
| Quail | 36.0 – 37.5°C | 96.8 – 99.5°F |
| Ducks | 36.0 – 37.5°C | 96.8 – 99.5°F |
| Geese | 36.0 – 37.5°C | 96.8 – 99.5°F |

OvaEasy Series III incubators have a built-in temperature alarm which warns of high or low incubation temperature and room temperature. See section 5 for details.

8. Humidity, Ventilation and Hatching

The generally accepted humidity level for hatching most species is 60%RH or higher. Avoid excessive humidity over 70% as this will condense as water on surfaces and may drip on the eggs. It also increases the time needed for chicks to dry.

If the humidity level in the hatcher is lower than the Set Humidity Level the pump will start to turn (sometimes brief pulses) and gradually draw water from the tank and pump it to the evaporation block in the hatcher. This may take a few hours to pump through and stabilise after which the pump will run intermittently as the humidity level is controlled.

Two main factors affect incubation humidity: water evaporation within the cabinet (from eggs as well as from additional water) and levels of ventilation. The water content of the air being drawn through the hatcher will also have an effect. In general, the adjustable vent should be set to its minimum to give optimum control.

SETTING THE HUMIDITY LEVEL



Press the - and + buttons simultaneously to unlock the Control Menu



Scroll to the RH% option and press OK to select the RH% screen.



Adjust as necessary using the + and - button.



Press OK to return to the Control Menu and then scroll down to SAVE. Press OK to save the changes.

The pump will not run if the hatcher is significantly below the set temperature. This is to prevent the system adding too much water when the door has been opened for inspecting eggs etc.

During hatching the high humidity levels will fall dramatically when the door is opened and will take some time to build up. Resist the temptation to open the door frequently – leave for at least 6 hours between inspections.

The control system may be set to control between 20 and 80% RH. In practice the minimum and maximum levels of humidity achievable in an incubator depend upon several factors including the ambient conditions in the incubation room. You may need to allow 24 hours for humidity to fully stabilise after making changes.

If you cannot achieve the relative humidity level required consider these notes:

Humidity will not go low enough

- The humidity control system can only increase humidity, not actively reduce it. Open the vent fully to help.
- A lower limit will be determined by the moisture content of the ambient air, particularly in warm humid conditions. This can only be countered by dehumidification of the room air outside the hatcher with a proprietary dehumidifier but is rarely a problem in practice.

Humidity will not go high enough

- Close the vent to its minimum setting to help.
- Check that water is reaching the hatcher when the pump runs – if not check the whole length of the tubing for kinks and check that the tubing around the pump has not become permanently flattened. If it has, try stretching it gently to open it. If that fails replace the pump tube (see page 7). Silicone tubing is very flexible but can be damaged by sharp finger nails. A tiny perforation on the suction side of the pump will let in air and prevent the pump drawing water.
- The tubing around the pump must be replaced periodically, typically every three months but this varies with use. See page 7 for details.

Condensation

- Under certain conditions it is possible that condensation may form on the inner walls. The presence of water gathering at the base of the hatcher or inside the door does not affect the performance of your hatcher and does not pose an electrical hazard. It is often an indication that room temperature is falling too low at night.

Adjustable ventilation

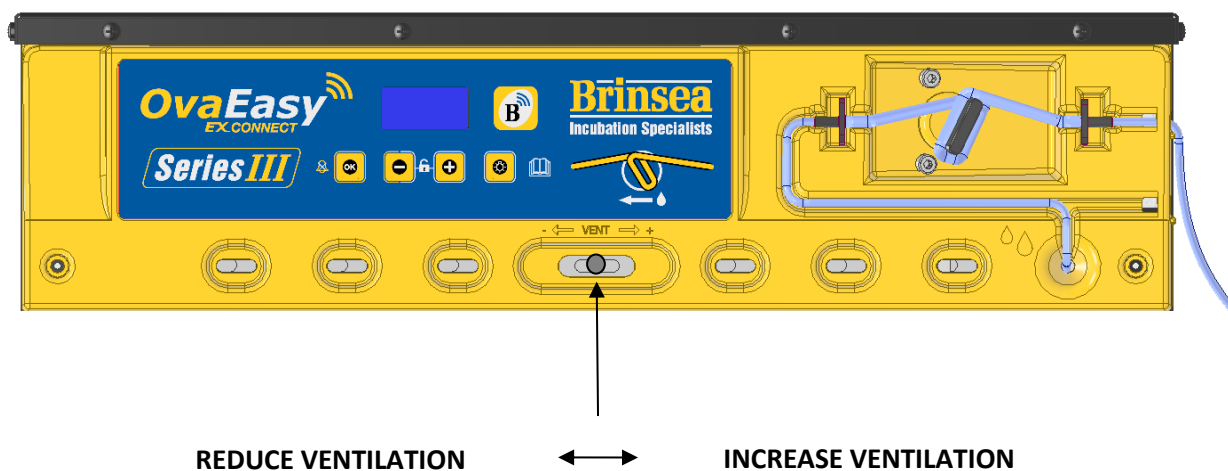

In general, the adjustable vent should be set to its minimum to give optimum control of humidity but may be opened to reduce excessive humidity after hatching.

To assemble the hatching tray(s) remove the dividers from an OvaEasy universal tray and place a white plastic peg in each of the four corner sockets. The wide end of the peg should make a push fit into the socket. Another universal tray may then be placed upside-down over the narrow end of the pegs to form a secure lid over the hatching eggs. When the lid is removed the pegs will stay fixed in the bottom tray.

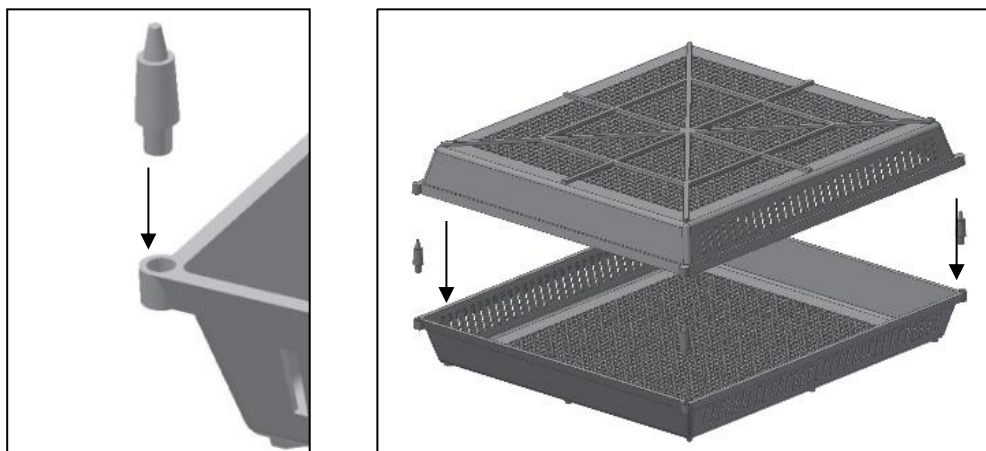

9. Cleaning Up

IMPORTANT:

DISCONNECT THE HATCHER FROM THE MAINS POWER SUPPLY DURING CLEANING.

ENSURE THAT ALL ELECTRICAL PARTS ARE KEPT DRY.

NEVER WASH THE TRAYS, INSULATED PANELS, FASCIA OR EVAPORATION TRAY PARTS WITH LIQUIDS OVER 50°C (120°F). DO NOT USE A DISHWASHER TO CLEAN THESE PARTS.

Following each hatch remove and wash the egg trays in Incubation Disinfectant Solution. Wipe all other internal surfaces with a soft cloth soaked in the solution. Ensure that the instructions supplied with the fluid are followed. Dust and fluff may be removed from the fan guard area with a soft brush.

The exterior of the hatcher may be cleaned with a damp cloth. Avoid allowing any moisture to get inside the top electrical housing or electrical connector at rear.

Always clean the hatcher before storage and ensure that the unit is totally dry inside and out.

10. Trouble-shooting and Calibration

Under certain conditions it is possible that condensation may form on the inner walls. The presence of water gathering at the base of the hatcher or inside the door does not affect the performance of your hatcher and does not pose an electrical hazard. It is often an indication that room temperature is falling too low at night.

In case of failure first check that the mains power supply is working and that the mains cable connector is fully engaged in the socket on the rear panel. The digital control system may be reset to the original factory defaults by connecting the power supply while holding the OK button.

Error messages:

SENSOR ERROR – The control system communicates to the temperature and humidity sensor with a digital signal that under normal conditions is highly tolerant of external electrical disturbances. However, if the signal becomes interrupted and cannot be recovered automatically the control displays **SENSOR ERROR**. This may be caused by:

- Strong electrical interference perhaps from a faulty appliance or lights. Restart the hatcher and try a different power socket or a “surge protector” type socket adaptor.

If the problem persists contact your distributor or Brinsea Products Service Dept.

The digital temperature and humidity display is individually calibrated during manufacture but may be re-calibrated if required. In the unlikely event that your hatching success makes you doubt the temperature or humidity calibration of your machine please contact your distributor or Brinsea directly at sales@brinsea.co.uk for further information and advice.

BE CAUTIOUS OF LOW COST ANALOGUE OR DIGITAL THERMOMETERS AND HYGROMETERS.

BRINSEA PRODUCTS LTD USES SOPHISTICATED EQUIPMENT TRACEABLE TO INTERNATIONAL REFERENCE STANDARDS.

11. Specification

Maximum Approximate Capacities:

| Egg size | Approximate Capacity |
|----------|----------------------|
| Quail | 500 |
| Pheasant | 274 |
| Hen | 192 |
| Duck | 140 |
| Goose | 72 |

Dimensions:

620 x 420 x 480mm (24.5” x 16.5” x 19”) H x W x D

Weight:

24Kg (53lbs)

Power Consumption:

| | |
|-------------------|-----------|
| Maximum | 200 Watts |
| (typical average) | 100 Watts |

Electrical Supply: 230v 50Hz or 110V 60Hz (as ordered)

Radio frequency band: 2.4GHz Wi-Fi (Channels 1 – 11 only)

Maximum effective isotropic radiated power 2412 – 2462 MHz 13.66dBm



Used electrical and electronic products should not be mixed with general household waste. For proper treatment, recovery and recycling, please take this product to a designated collection point where it will be accepted free of charge.

Please contact your local authority for further details of your nearest designated collection point.

Disposing of this product correctly will help save valuable resources and prevent any potential negative effects on human health and the environment, which could otherwise arise from inappropriate waste handling.

Brinsea Products Ltd, 32-33 Buckingham Road, Weston Industrial Estate,
Weston-super-Mare, N. Somerset, BS24 9BG

Tel: +44 (0) 345 226 0120

e-mail: support@brinsea.co.uk, website: www.brinsea.co.uk

Declaration of Conformity

We: BRINSEA PRODUCTS LTD.
32-33 Buckingham Road
Weston Industrial Estate
Weston-super-Mare
North Somerset
BS24 9BG

Declare under our sole responsibility the products:

Egg Incubators:

Ova-Easy Hatcher EX Connect Series III (Serial numbers MJ4944x/xxxxxxxxx)

to which this declaration relates are in conformity with the following UK regulations:

Radio Equipment Regulations 2017

The Restriction of the Use of Certain Hazardous Substances in Electrical and Electronic Equipment Regulations 2012

The relevant sections of the following Standards have been used:

BS EN 60335-1:2012+A15:2021
BS EN 60335-2-71:2003+A1:2007
BS EN 55014-1:2017+A11:2020
BS EN 55014-2:2015
ETSI EN 300 328 V2.2.2
BS EN 62479:2010
EN 18031-1:2024
BS EN 63000:2018

The technical documentation for the products is available from the above address.

Authorised Representative: Ian Pearce, Managing Director

Signature:

Date of Issue: 31 March 2026

Place of Issue: 32-33 Buckingham Road, Weston Industrial Estate, Weston-super-Mare, North Somerset, BS24 9BG, United Kingdom.

EU Declaration of Conformity

In accordance with European Parliament and Council
Decision No 768/2008/EC Annex III

1. Radio equipment model / product:

Product: Egg incubator
Model: OvaEasy Hatcher EX Connect Series III (Serial Numbers MJ4944x/xxxxxxxxx)

2. Manufacturer:

Name: Brinsea Products Ltd.
Address: 32-33 Buckingham Road, Weston Industrial Estate,
Weston-super-Mare, BS24 9BG, England

Authorised Representative:

Name: Authorised Rep Compliance Ltd.
Address: Ground Floor, 71 Lower Baggot Street, Dublin, D02 P593, Ireland

3. This declaration is issued under the sole responsibility of the manufacturer.

4. Object of the declaration:

Product: OvaEasy 100 EX Connect Series III egg incubators
Specification: 220-240V, 50Hz, 200W, capacity 192 eggs.

5. The object of the declaration described above is in conformity with the relevant EU harmonisation legislation:

2014/53/EU Radio Equipment Directive
2011/65/EU Restriction on the use of certain hazardous substances (RoHS)

6. References to the relevant harmonised standards used or references to the other technical specifications in relation to which conformity is declared:

EN 60335-1:2012+A15:2021
EN 60335-2-71:2003+A1:2007
EN 55014-1:2017+A11:2020
EN 55014-2:2015
ETSI EN 300 328 V2.2.2
EN 62479:2010
EN 18031-1:2024
EN IEC 63000:2018

7. The technical documentation for the product is available from the authorised representative at the address above.

Signed for and on behalf of: Brinsea Products Ltd.

Place of issue: Weston-super-Mare

Date of issue: 31 March 2026

Name: Ian Pearce

Function: Managing Director

Signature:

Statement of Compliance

Product:

Egg Incubators:

OvaEasy 100 EX Connect Series III (Serial numbers MJ1044x/xxxxxxxxx)
OvaEasy 190 EX Connect Series III (Serial numbers MJ1944x/xxxxxxxxx)
OvaEasy 380 EX Connect Series III (Serial numbers MJ3844x/xxxxxxxxx)
OvaEasy 580 EX Connect Series III (Serial numbers MJ5844x/xxxxxxxxx)
OvaEasy Hatcher EX Connect Series III (Serial numbers MJ4944x/xxxxxxxxx)

Name and address of manufacturer:

BRINSEA PRODUCTS LTD.
32-33 Buckingham Road
Weston Industrial Estate
Weston-super-Mare
North Somerset
BS24 9BG

This declaration of compliance is prepared by the manufacturer of this product.

We, the manufacturer, declare that in our opinion we have complied with:

The Product Security and Telecommunications Infrastructure (Security Requirements for Relevant Connectable Products) Regulations 2023 – Schedule 2

The relevant sections of the following Standards have been used:

ETSI EN 303 645 V2.1.1 (issued 2020-06) (provision 5.1-1, 5.1-2, 5.2-1, 5.3-13)

The defined support period for the product is one year.

Signed for and on behalf of the manufacturer:

Name: Ian Pearce,

Function: Managing Director

Signature:

Date of Issue: 31 March 2026

Place of Issue: 32-33 Buckingham Road, Weston Industrial Estate, Weston-super-Mare, North Somerset, BS24 9BG, United Kingdom.