

Mini II ^{Wi-Fi} Egg Incubator
EX CONNECT
Operating Manual

Brinsea
Incubation Specialists



Authorised Representative :
Authorised Rep Compliance Ltd.
Ground Floor, 71 Lower Baggot
Street, Dublin, D02 P593, Ireland



Read the instructions before use!



Do not cover!

This appliance is only to be used with the power supply unit provided with the appliance.

Damaged appliances must not be used.

The appliance and its supply cord must be placed in an indoor area not subject to splashes of water or wet conditions and protected from or out of reach of animals.

Repairs must be carried out only by a suitably qualified person.

This appliance must not be used, cleaned or maintained by children or persons with reduced physical, sensory or mental capabilities or lack of experience and knowledge without supervision. Children must not play with the appliance.

Disconnect the incubator from the mains power supply during cleaning. Ensure that all electrical parts are kept dry.

Please read these instructions carefully before setting up your incubator to achieve best results and keep these instructions safe for future reference.

This document includes recommended procedures for successful hatching but incubation involves the control and manipulation of a large number of factors and in certain circumstances different procedures may be necessary.

For more detailed information on all aspects of egg incubation including helpful advice on getting best results please visit our website at www.brinsea.co.uk.

Your incubator is designed to allow the user to vary the incubation conditions to suit a wide range of species in different ambient conditions and the specific set-up for every situation is beyond the scope of these instructions.

For more information on incubation and hatching please download our FREE Incubation Handbook: www.brinsea.co.uk/incubationhandbook, for more species specific advice a range of publications can be found at: www.brinsea.co.uk/books.

To register your new Brinsea product please visit www.brinsea.co.uk within 30 days of purchase and follow the link on the home page to qualify for your free 3 year guarantee. Sign up for the Brinsea Newsletter to receive the latest news and information.



CONTENTS

1	Setting Up Your Incubator	-
	Unpacking & Part Quantities	4
	Assembly	5
	Pump Setup	8
	Location & Installation	10
	Installing the Brinsea Connect App and System Updates	11
2	Product Introduction – Functional Features	12
3	Settings – Control Menu	13
4	Display	14
5	Temperature	16
6	Humidity	17
7	Eggs	19
8	Periodic Incubation Cooling	21
9	Hatching & Cleaning up	22
10	Specifications and Erasing Personal Data	23

1 SETTING UP YOUR INCUBATOR

UNPACKING & PART QUANTITIES

Your incubator has been supplied in protective packaging. Please remove all tape, strapping and packing from the incubator and parts. Retain the carton and packing materials to enable the unit to be repacked.

Lift the top off, take out the power supply unit and remove all packaging. Check that your electrical supply matches that marked on the power supply unit.

The diagram shows all the parts that have been supplied to you. Ensure you have the correct quantities of each part. If there are any parts damaged or missing please contact your retailer or Brinsea Products (at the address at the end of the document). **Damaged appliances must not be used.**

- 1:** Pump Connector (2)
- 2:** Water Pump Tubing (70mm)
- 3:** Flexible Link Tubing (90mm)
- 4:** Rigid Water Tubing (110mm)
- 5:** Pump Cover
- 6:** Top
- 7:** Water Pot Guard
- 8:** Standard Egg Disc
- 9:** Base
- 10:** Water Evaporation Card (2 Sheets)
- 11:** Water Tubing (3m)
- 12:** Hatching Mat
- 13:** Small Egg Disc
- 14:** Power Supply Unit (not shown in diagram)

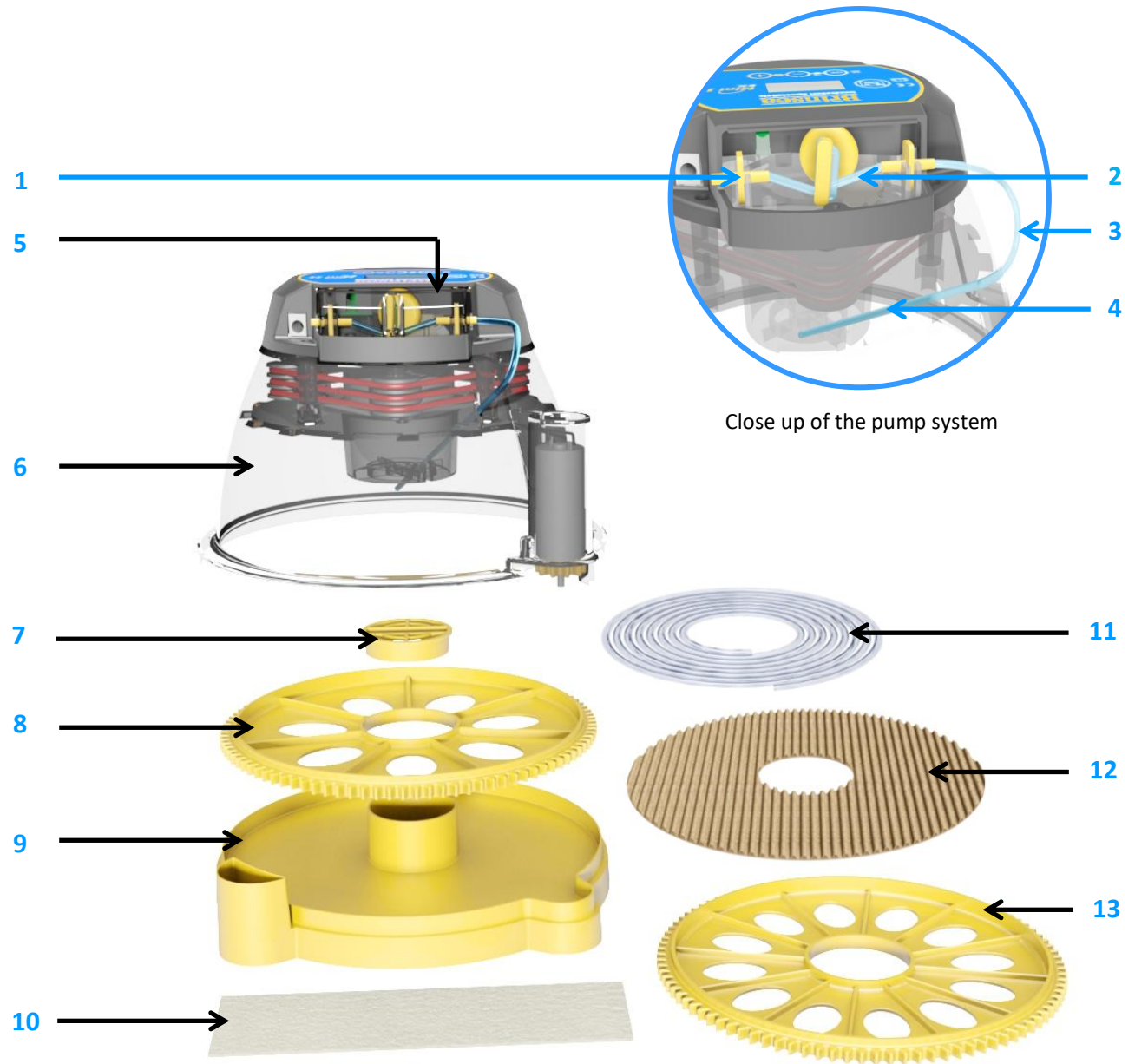

1 SETTING UP YOUR INCUBATOR

ASSEMBLY

1: Cut a piece of the evaporating card to approximately 45mm wide (1 3/4") by 125mm long (5") and fold it in half lengthwise. Once folded, place the evaporating card over the central rib in the water pot ensuring the card is touching the bottom.

2: Fit the water pot guard to prevent chicks from drowning.

Ensure the evaporation card fits through the slot in the water pot guard to make sure it stays in position (as shown in image 2).

Do not add any water to the water pot.

1.

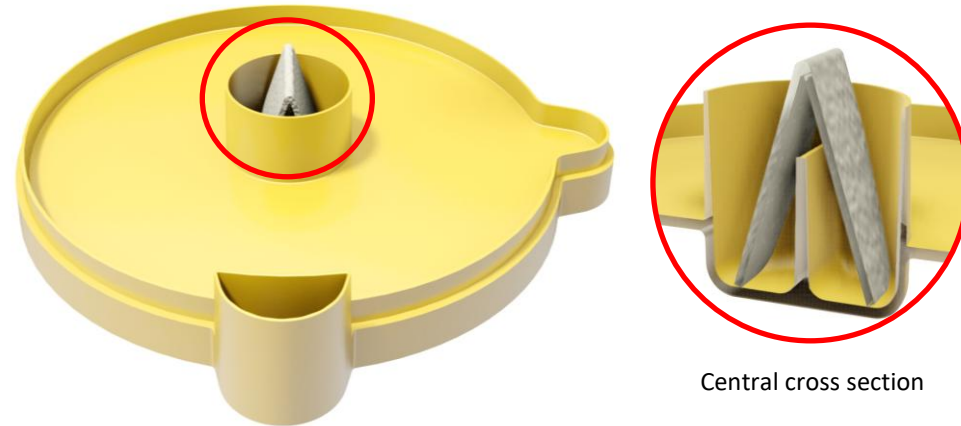

2.

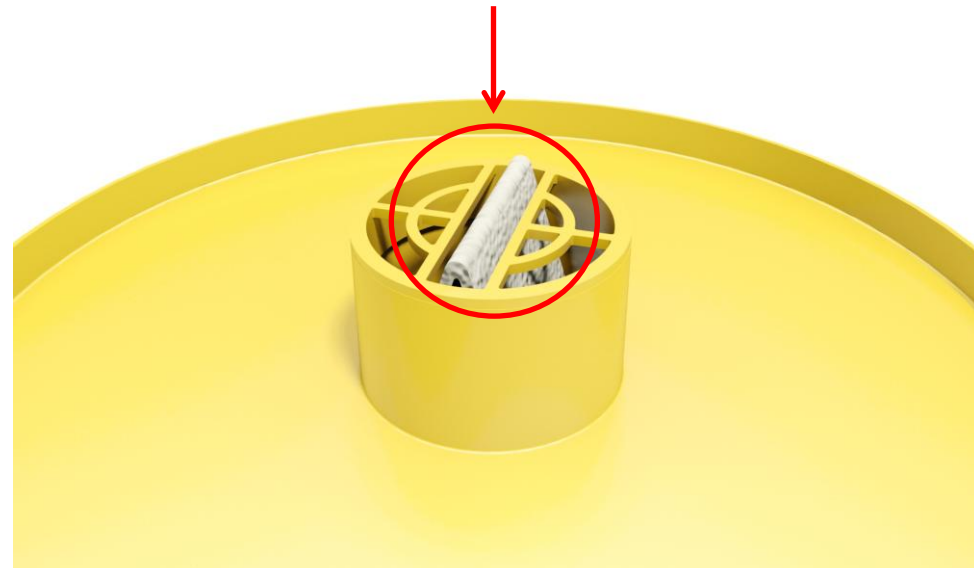

1 SETTING UP YOUR INCUBATOR

ASSEMBLY

3: Place the desired egg disc in the base of the incubator, ribbed side up.

4: Place the top onto the base. Check the top fits flush all the way around the base edge.

3.

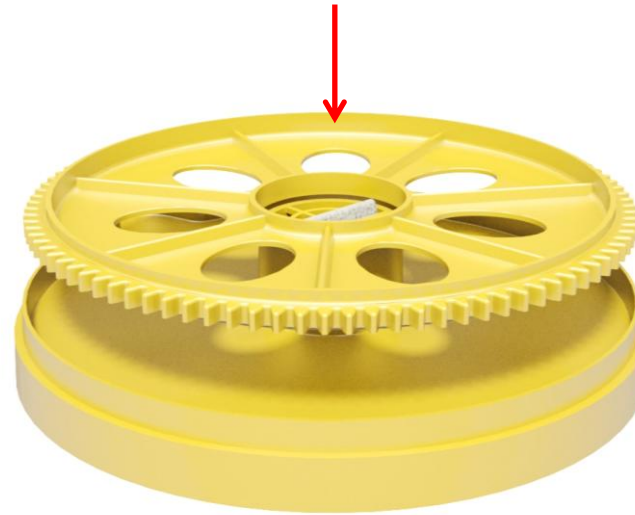

4.

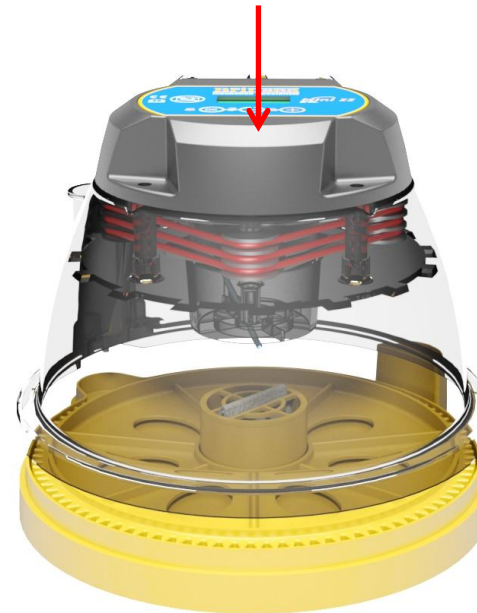

1 SETTING UP YOUR INCUBATOR

ASSEMBLY

5: Find a suitable water container (0.5 to 1.0L). Place next to the incubator.

IMPORTANT: Do not place the water container on top of the incubator or higher than the incubator. This is to prevent the water siphoning through and flooding the incubator. The water container is best placed next to the incubator on the same surface.

Please ensure the incubator is used on a water resistant surface.

5.



1 SETTING UP YOUR INCUBATOR

PUMP SETUP

The Mini II EX Connect incubator uses a peristaltic water metering pump to automatically control the relative humidity of the air in the egg chamber. Pumped water is fed to the evaporation card where warm air is drawn over the surface to effectively evaporate all the water (none should collect under normal conditions). This humidified air is then mixed within the heating chamber so that the air drawn across the eggs is of uniform humidity and temperature.

The pump is supplied with a water pump tube (70mm long), a flexible link tube (90mm), a rigid water tube (110mm) and two pump connectors that are fitted at each end of the water pump tube. See page 4 for full pump system diagram. The water pump system is supplied part assembled, you only need to check everything is in the correct position and wrap the water pump tube around the capstan using the steps below.

1: Make sure the rigid tube is in the correct position with the bottom end protruding through the slot in the fan grill and locating centrally above the water pot guard. Ensure the water will drip onto the evaporation card as shown.

2: Ensure that the flexible link tube is attached to the rigid water tube at one end and the pump connector at the other end.

3: Cut a length of silicone water tubing to connect the pump to the water container. Leave enough spare so that the incubator top can be easily removed and placed to one side. Attach one end of the water container tube onto the pump connector as shown and feed the other end of the tube into your water container.

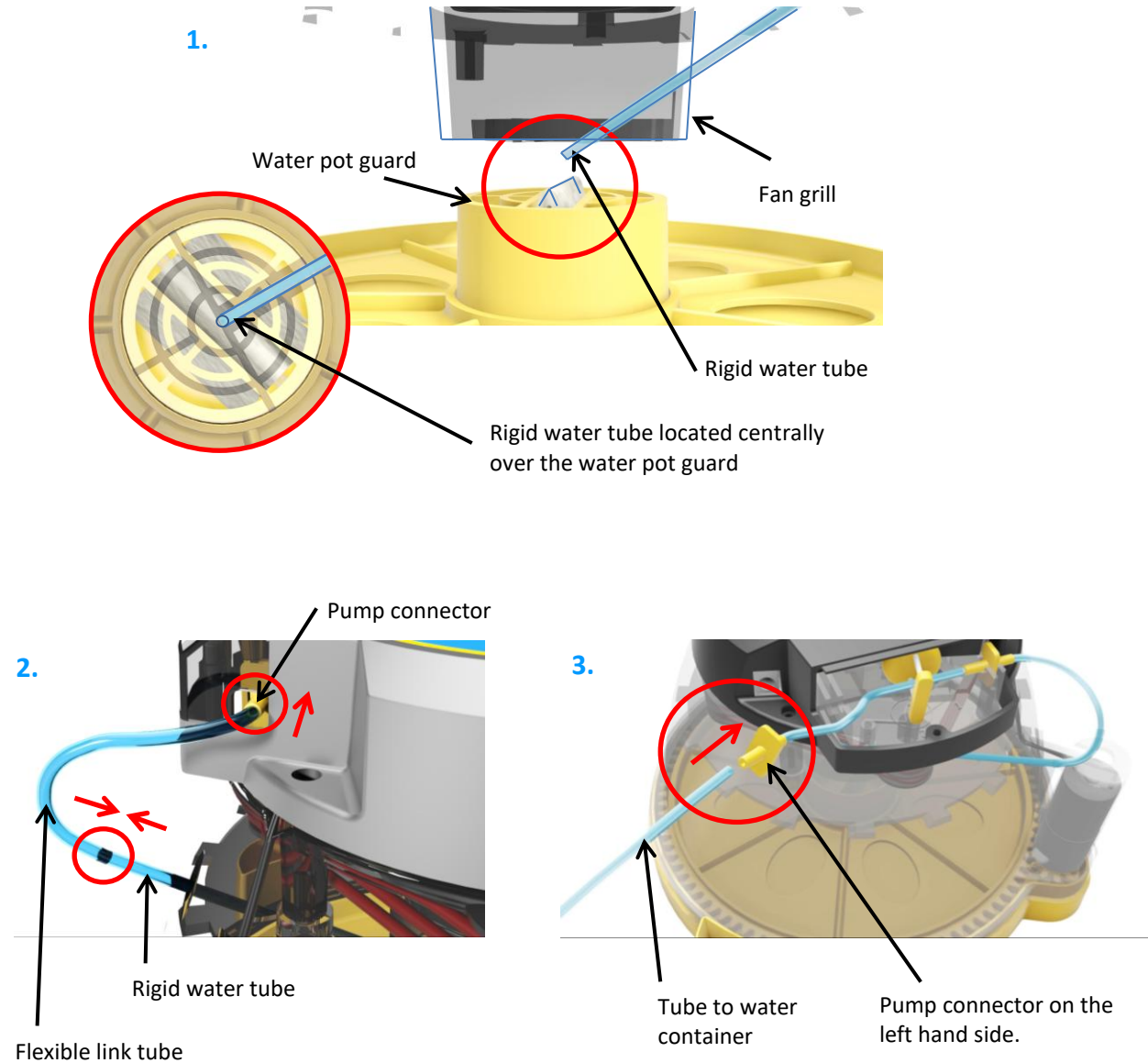

1 SETTING UP YOUR INCUBATOR

PUMP SETUP

4: Make sure the first pump connector is still in its slot as shown. Pull the other pump connector (for the water container) and pump tube down under the capstan, wrap around and pull over into the pump connector's slot. Follow the diagram on the incubator, 1 – 2 – 3.

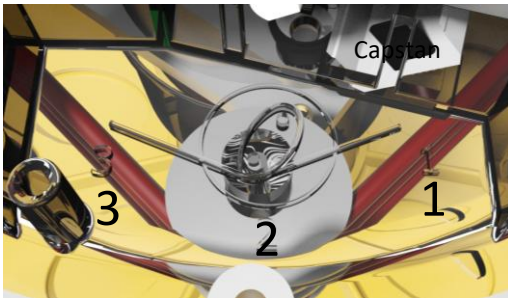

5: Fit the pump cover in place and gently tighten the screw.

Check the water level in your water container regularly.

Please check the condition of the tubes after each use. The peristaltic pump will need to have its water pump tube replaced about every 3 months. Cut a length of tube to 70mm. Remove the connectors and pull off the old tube. Replace with the new tube, avoiding twists. Use the diagram on the product to assist and follow the instructions above.

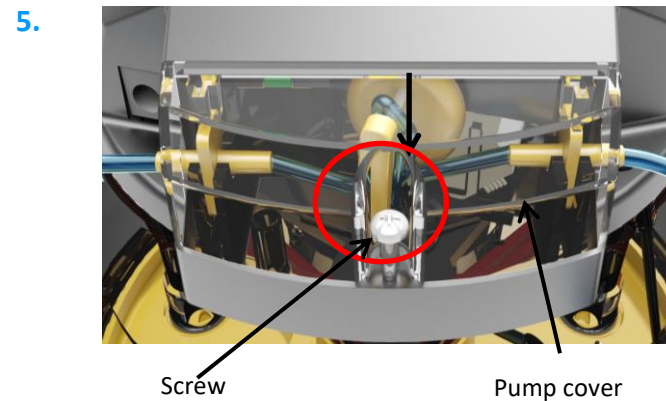
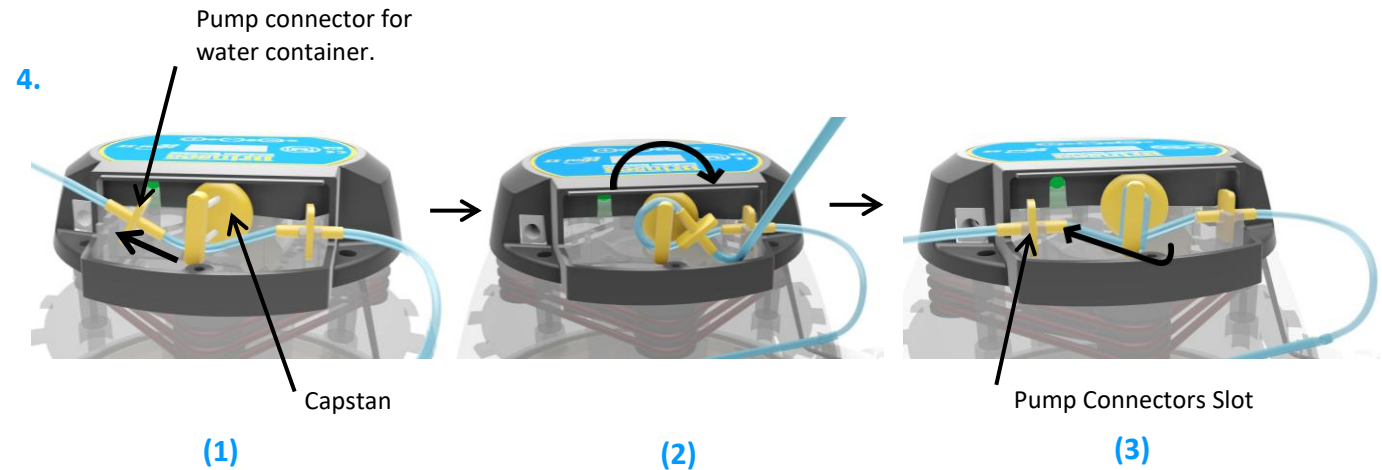

Water pump tube diagram to scale

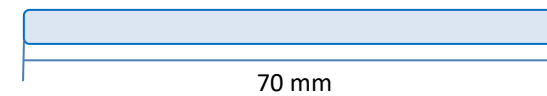

Flexible link tube diagram to scale

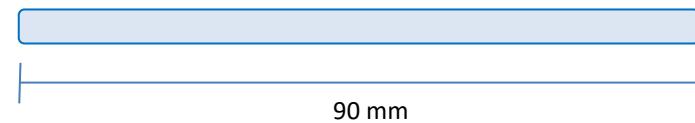

1 SETTING UP YOUR INCUBATOR

LOCATION AND INSTALLATION

Your incubator will give best results in a heated room free from wide temperature variations and with generous ventilation – particularly if several incubators are running at the same time.

Ensure that the room temperature cannot drop on a cold night. Ideally thermostatically control the room at between 20 and 25°C (68 and 77°F). Never allow the room temperature to drop below 17°C (63°F).

Make sure that the incubator cannot be exposed to direct sunlight and is used on a flat, level surfaced worktop or table, not on the floor.

Connect the power cable to the incubator lid. Ensure the connector is pushed fully home in its socket.

Only use the power supply unit supplied with the product. Use of a different power supply may cause a hazard and will invalidate any guarantee.

1.

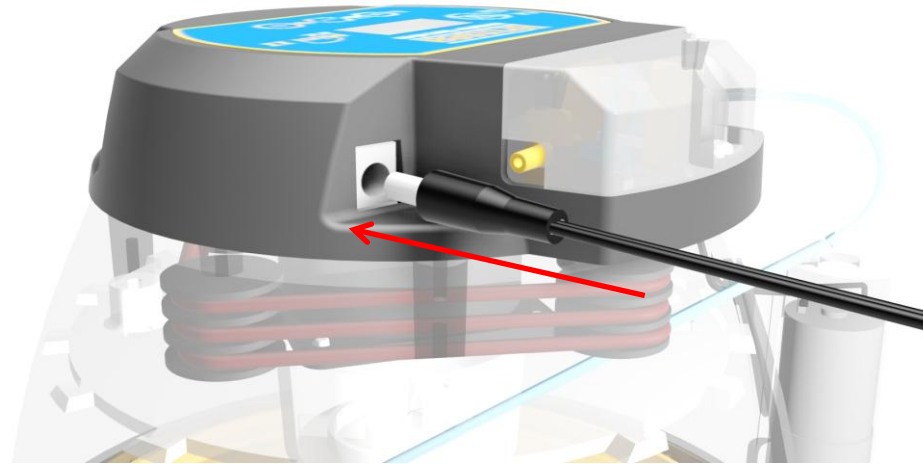

2.



1 SETTING UP YOUR INCUBATOR

THE BRINSEA CONNECT APP

The Brinsea Connect App links to your Connect incubator and means your smartphone can:

- Monitor temperature, humidity, turning, cooling and count-down to hatch day.
- Be alerted with a phone notification to warning alarms of fluctuations in temperature, humidity and power loss.
- Change temperature, humidity, cooling and turning settings
- Future-proof your incubator/app system with future additional features as they become available.

Remote functions require connection to a Wi-Fi network. The incubator will function normally and there is no risk to incubating eggs if internet connection is lost.

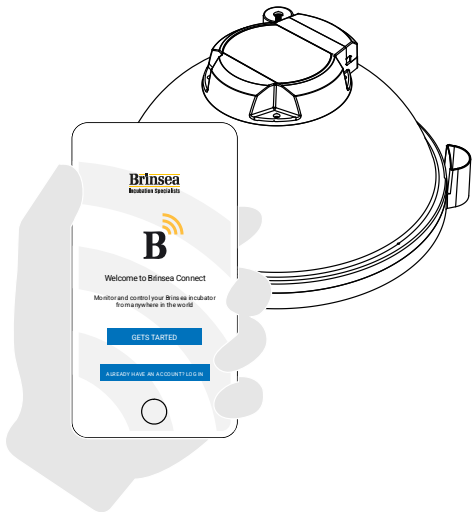

1. INSTALL THE APP

In order to use the connected functionality of your Mini II EX Connect, you will need to install the Brinsea Connect App on your smartphone.

If you have an Apple device, search the App Store for the Brinsea Connect App.

If you have an Android device, search the Google Play Store for the Brinsea Connect App.



2. CONNECT THE INCUBATOR TO A WI-FI NETWORK

Once the Brinsea Connect App is installed, follow the instructions on the app to connect your incubator to your home Wi-Fi network.

Make sure you know your home Wi-Fi network ID and password; it will be needed to connect the incubator to the network.

The app contains links to trouble-shooting tips in the Options page Help and Information section.

3. INSTALL ANY INCUBATOR SYSTEM UPDATES

Once your incubator has been connected to the Brinsea Server and the Wi-Fi network is available, each time power is disconnected and then reconnected a check will be automatically made for any available incubator control system updates. The control panel on the incubator will show "Update?" when one is available. It is recommended to perform this check when using your incubator for the first time.

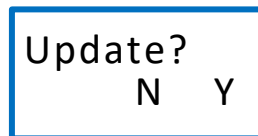

Press the + button (Y) to install. This may take several minutes. Do not unplug or turn off your incubator while it is being updated. Updates may include improvements to security or other fixes and it is recommended to install updates when available. If the internet connection is interrupted during an update the system may need to repeat the process.

2 PRODUCT INTRODUCTION

FUNCTIONAL FEATURES

1: Digital Display

2: Control Buttons

3: Pump Cover

4: Egg Discs (2)

5: External Fill Point

The external fill point should not be used in conjunction with the pump system.

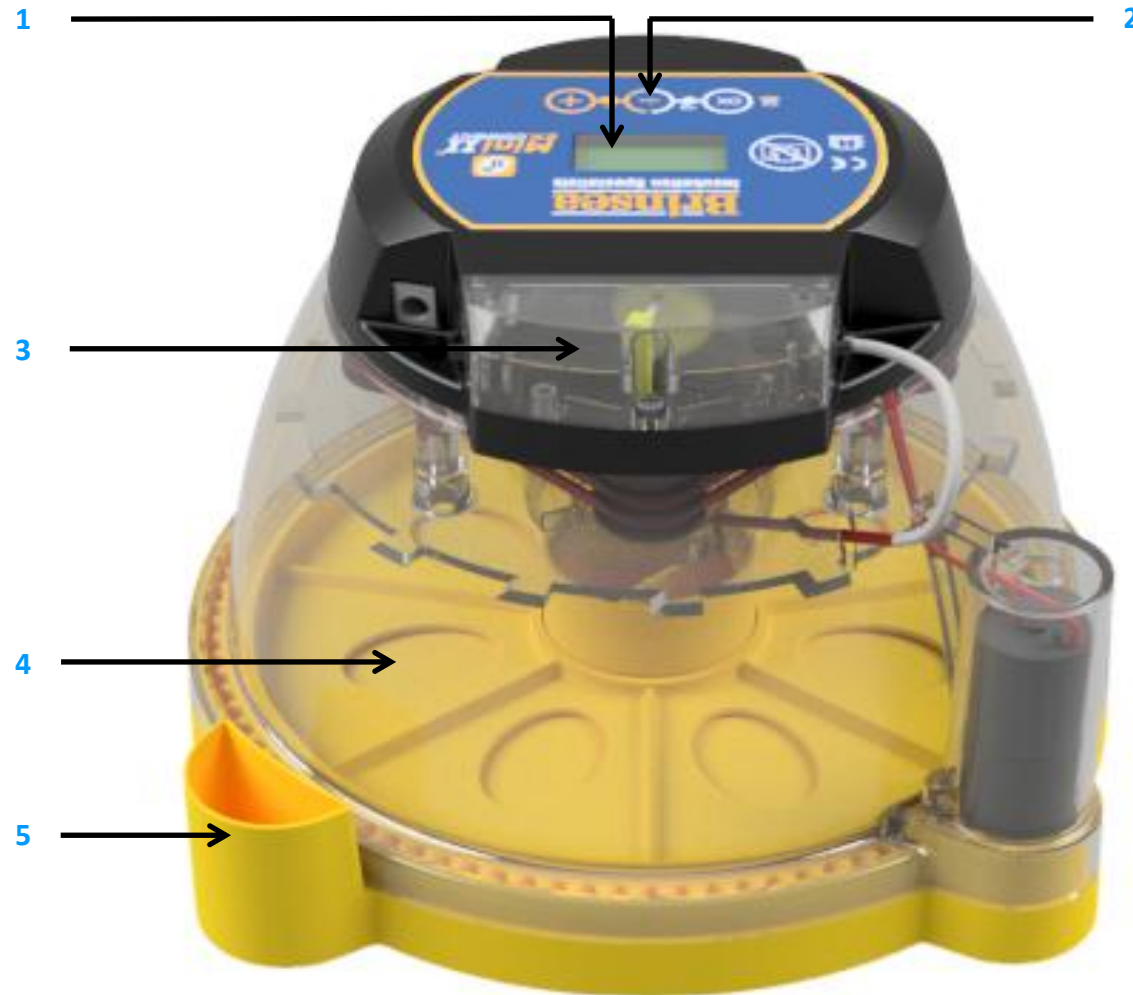

3 SETTINGS

CONTROL MENU

The diagram on the right illustrates how to navigate through the control menu. Look at the key below to understand what each button does when pressed.



Press both buttons to unlock the menu.



Select the option / return to the menu.



Go forward one screen / increase the value / display in Celsius.



Go back one screen / decrease the value / display in Fahrenheit.

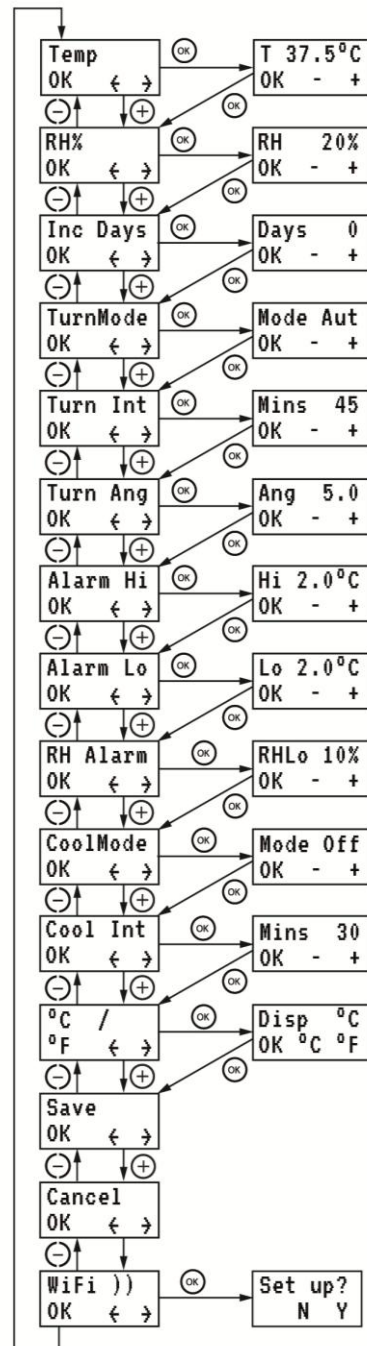

INCUBATION TEMPERATURE

Range 20.0 – 40.0°C (68.0 – 104.0°F). Default 37.5°C (99.5°F). See section 5.

RELATIVE HUMIDITY

Range 20% – 80%. Default 20%. See section 6.

INCUBATION DAYS

The number of days left until the eggs are due to hatch. Must be set for each new batch. Range 40-0 days. Default 21. See section 6.

TURNING MODE

Switches the turning system to on, automatic or off. Default ON.

TURNING INTERVAL

Sets the delay between turns. Range 5 – 180 minutes. Default 45 minutes.

TURNING ANGLE

Sets the angle of egg turning by how long the motor runs. Range 1 – 20 seconds. Default 5 seconds. See section 7.

HIGH TEMPERATURE ALARM

Range 1.0 – 5.0°C (1.8 – 9.0°F) above set incubation temperature. Default 2.0°C (3.6°F). See section 4.

LOW TEMPERATURE ALARM

Range 1.0 – 5.0°C (1.8 – 9.0°F) below set incubation temperature. Default 3.0°C (5.4°F). See section 4.

LOW HUMIDITY ALARM

Range 10-50%RH below set humidity. Default 10%RH. See section 4.

PERIODIC COOLING MODE

Switches heater off for a timed period once every 24 hours. **Do not use before day 7 of incubation or whilst hatching.** Default – OFF. See section 8.

PERIODIC COOLING INTERVAL

Range 10 – 360 minutes. Default – 30. See section 8.

CELSIUS / FAHRENHEIT DISPLAY

Switches all temperature figures between °C and °F. Default °C. See section 5.

SAVE

All changes are saved. Return to normal operation screen.

CANCEL

All changes are ignored. Return to normal operation screen.

Wi-Fi

Enter Wi-Fi setup mode when using Brinsea Connect App.

4 DISPLAY

DIGITAL CONTROL SYSTEM

The Mini II EX Connect control system utilises a highly accurate, individually calibrated sensor for temperature. Be cautious of low-cost analogue or digital thermometers when comparing them with the incubator display reading.

Example settings for poultry:

Temperature: 37.5°C
Humidity: 45%
Incubation days: 21
Turning interval: 45 minutes (turn off from day 19 and remove egg quadrants)
Turning Angle: 7 seconds
Cooling: OFF

(Do not manually add water to the water pans when the automatic humidity control system is being used)

(FIG 1)

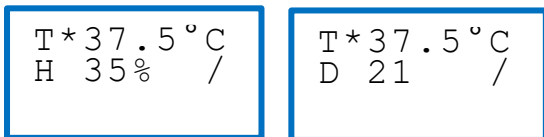

(FIG 2)

T*37.5°C
H*35% P/

Normal Operation (FIG 1) – Temperature, relative humidity and turn system status are continuously displayed.

- The asterisk "*" adjacent to the temperature reading shows when the heater power is on. When warming the asterisk will be continuously on, once warmed up the asterisk will slowly flash as the heater is pulsed to maintain the correct temperature. When reducing the temperature setting the asterisk may go off, this is normal.
 - During periodic incubation cooling (see section 8) the asterisk will be replaced by an arrow: "↓".
 - The lower line of the display will alternate between showing the humidity reading and the number of days left until hatching.
 - The asterisk "*" adjacent to the humidity reading shows when the pump output is active (see section 8). The pump output will not come on until the incubator is up to operating temperature and the set humidity level is greater than the measured humidity level in the incubator.
 - If turning is switched off an "O" flashes at the lower-right corner of the display.
 - If turning is switched on a line "/" symbol rotates at the lower-right corner of the display.
 - If turning is set to auto the lower-right corner of the display will alternate between a rotating line "/" symbol and an "A"
- If the incubation timer has reached its final 2 days, turning will stop and the lower-right corner of the display will alternate between a rotating line and an "O"

Changing Settings – The Control Menu allows the various settings to be modified and saved. All settings are retained in the event of a power cut.

- To access the Control Menu, press the + and – buttons simultaneously to unlock the display. For full details of menu settings please refer to the contents on page 3 and view the relevant sections.

Power Loss Display (FIG 2) – If power has been interrupted due to a power cut (or when first switching on) a "P" is shown flashing in the corner of the display. Press OK for 2 or more seconds to clear the indicator. If the reason for the power loss is not known check the power cable connections are secure.

- Once the "P" indicator has been cleared, it is advisable to candle eggs a number of times to check for losses.

4 DISPLAY

(FIG 3)

T* 39.8°C
H 35% H/

(FIG 4)

T* 32.1°C
H 35% L/

(FIG 5)

T* 37.5°C
-RM /

(FIG 6)

T* 37.5°C
+RM /

(FIG 7)

T* 39.8°C
H* 35% /

High Temperature Alarm Display (FIG 3) – If the temperature inside the incubator rises above the ALARM HI value, the alarm will sound immediately and “H” will be displayed. Press OK to silence the alarm for 30 minutes.

- If the high temperature problem rectifies itself the “H” remains on the display to show this has happened. Press OK to clear the indicator. Check the incubator is not (and has not been) in direct sunlight or too near a heat source such as a room heater. It is advisable to candle eggs a number of times after this event to check for losses.

Low Temperature Alarm Display (FIG 4) – If the temperature inside the incubator drops below the ALARM LO value, after 60 minutes the alarm will sound and “L” will be displayed. Press OK to silence the alarm for 30 minutes.

- If the low temperature problem rectifies itself the “L” remains on the display to show this has happened. Press OK to clear the indicator. Check the incubator is not (and has not been) in a cold draught or that the room temperature has dropped significantly. It is advisable to candle eggs a number of times after this event to check for losses.

Low Room Temperature Alarm (FIG 5) – If the calculated room temperature drops below a sufficient level for more than 1 hour an alarm will sound and the warning “-RM” is displayed. Press OK to silence the alarm for 30 minutes.

- If the low temperature problem rectifies itself the “-RM” remains on the display to show this has happened. Press OK to clear the indicator.
- Check the incubator is not (and has not been) in a cold draught or that the room temperature has not dropped significantly. It is advisable to candle eggs a number of times after this event to check for losses.

High Room Temperature Alarm (FIG 6) – If the calculated room temperature remains too high for more than 1 hour an alarm will sound and the warning “+RM” is displayed. Press OK to silence the alarm for 30 minutes.

- If the high temperature problem rectifies itself the “+RM” remains on the display to show this has happened. Press OK to clear the indicator.
- Check the incubator is not (and has not been) in direct sunlight or too near a heat source such as a room heater. The eggs themselves create significant metabolic heating at later stages of incubation and may contribute to this if room temperature is high. It is advisable to candle eggs a number of times after this event to check for losses.

Low Humidity Alarm (FIG 7) – If the measured humidity inside the incubator drops below the value set in RH ALARM for more than 2 hours an alarm will sound and the humidity display will flash. Press OK to silence the alarm for 30 minutes.

- If the low humidity rectifies itself the display remains flashing to show this has happened. Press OK to clear the indicator.

5 TEMPERATURE

SETTING THE TEMPERATURE

- 

1. Press the - and + buttons simultaneously to unlock the Main Menu.
- 

2. Press OK to select the temperature screen and adjust as necessary using the + and - buttons.
- 

3. Press OK to return to the Main Menu and then scroll down to SAVE. Press OK to save the changes.

When reducing temperature the asterisk may go out while the incubator cools – this is normal. Adjust temperature with care – small differences have large effects on hatching performance.

CHANGING TO FAHRENHEIT

- 

1. Press the - and + buttons simultaneously to unlock the Main Menu.
- 

2. Scroll to the C/F option and press OK to select the C/F display screen.
- 

3. Press the + button to select °F or the - button to select °C.
- 

4. Press OK to return to the Main Menu and then scroll down to save. Press OK to save the changes.

Please Note: Your incubator will be factory set for hen eggs, you may wish to adjust the temperature in the menu to suit the types of eggs you are incubating.

As the incubator warms up and approaches its control setting the ‘heater on’ asterisk “*” will change from continuously on to flashing. Allow the incubator to stabilise for at least an hour before adjusting the temperature.

	Recommended temperatures:		Typical incubation period:
Hens	37.4 – 37.6°C	99.3 – 99.6°F	21 days
Pheasant	37.6 – 37.8°C	99.6 – 100.0°F	23-27 days
Quail	37.6 – 37.8°C	99.6 – 100.0°F	16-23 days
Ducks	37.4 – 37.6°C	99.3 – 99.6°F	28 days
Parrots:			
Amazons	36.8 – 37.0°C	98.3 – 98.6°F	24-29 days
Macaws	36.8 – 37.0°C	98.3 – 98.6°F	26-28 days
Love birds	36.8 – 37.0°C	98.3 – 98.6°F	22-24 days
African Grey	36.8 – 37.0°C	98.3 – 98.6°F	28 days
Eclectus	36.8 – 37.0°C	98.3 – 98.6°F	28 days

- Developing embryos are fairly tolerant of short term temperature drops and the user need not be concerned about cooling that occurs when inspecting eggs. Temperatures above ideal can quickly have a serious detrimental effect on hatch rates and must be avoided.
- The Mini II EX Connect has a built-in temperature alarm which warns of high or low temperatures. See section 4 for details.

6 HUMIDITY

UNDERSTANDING HUMIDITY

Short term variations in humidity are not important. The average humidity over the incubation period needs to be near optimum to achieve the ideal weight loss.

High humidity for the day or two of hatching is also important. Beware long term, excessive humidity.

HATCHING

If the humidity level in the incubator is lower than the Set Humidity Level the pump will start to turn (sometimes brief pulses) and gradually draw water from the tank and pump it to the evaporation card in the incubator.

This may take a few hours to pump through and stabilise after which the pump will run intermittently as the humidity level is controlled.

Typical Humidity:

Generally accepted incubation RH levels for species groups:

During incubation: Poultry	40-50% RH
Waterfowl	45-55% RH
Parrots	35-45% RH
Hatching: All species	65% RH or more

Typical Weight Loss:

Typical ideal weight losses for species groups:

Poultry	13%
Waterfowl	14%
Parrots	16%

For more specific information on particular species' requirements check the relevant literature.

Two factors affect incubation humidity: water evaporation within the cabinet (from eggs as well as from additional water) and levels of ventilation. The water content of the air being drawn through the incubator will also have an effect.

There are two methods available to bird breeders to achieve correct humidity levels:

- 1: Monitor humidity levels and adjust to match published guidelines for different species.**
- 2: Monitor egg weight loss which varies as a direct result of humidity and correct against published weight loss figures for the species. This is the most reliable method and is recommended – particularly where poor hatch rates are experienced or if eggs of high value are being incubated.**

Eggs lose moisture through their shells and the rate of evaporation depends on the humidity levels around the eggs and the shell porosity. During incubation eggs need to lose a fixed amount of water which corresponds to a loss in weight of around 13-16% depending on species. By weighing eggs periodically during incubation it is possible to monitor and, if necessary, correct humidity levels to achieve the correct weight loss.

For more detailed information on all aspects of egg incubation including helpful advice on getting best results please visit our website at www.brinsea.co.uk/incubationhandbook.

6 HUMIDITY

SETTING THE RELATIVE HUMIDITY LEVEL



1. Press the - and + buttons simultaneously to unlock the Main Menu.



2. Press the + button to scroll to the RH% option.



3. Press OK to select the RH% screen and adjust as necessary using the + and - buttons.



4. Press OK to return to the Main Menu and then scroll down to SAVE. Press OK to save the changes.

If the humidity level in the incubator is lower than the Set Humidity Level the pump will start to turn (sometimes brief pulses) and gradually draw water from the tank and pump it to the evaporation card in the incubator.

This may take a few hours to pump through and stabilise after which the pump will run intermittently as the humidity level is controlled.

The external fill point should not be used in conjunction with the pump system.

The pump will not run if the incubator is significantly below the set temperature (including during periodic incubation cooling – see section 8). This is to prevent the system adding too much water when the top has been opened for inspecting eggs etc.

In all cases the humidity for hatching needs to be high. Because of the short duration involved water/weight loss will not be significantly affected. High humidity is necessary to prevent membranes drying and hardening before the hatch fully emerges. Humidity will naturally increase as the first eggs begin to hatch and internal membranes begin to dry. This is in addition to the water added by the pump.

During hatching the high humidity levels will fall dramatically when the lid is opened and will take some time to build up. Resist the temptation to lift the lid frequently – leave for at least 6 hours between inspections.

The control system may be set to control between 20 and 80% RH. In practice the minimum and maximum levels of humidity achievable in an incubator depend upon several factors including the ambient conditions in the incubation room. You may need to allow 24 hours for humidity to fully stabilise after making changes.

If you cannot achieve the relative humidity level required consider these notes:

Humidity will not go low enough

- A lower limit will be determined by the moisture content of the ambient air, particularly in warm humid conditions. This can only be countered by dehumidification of the room air outside the incubator with a proprietary dehumidifier but is rarely a problem in practice.

Humidity will not go high enough

- Check that water is reaching the incubator when the pump runs – if not check the whole length of the tubing for kinks and check that the tubing around the pump has not become permanently flattened. If it has, try stretching it gently to open it. If that fails replace the pump tube (see page 9). Silicone tubing is very flexible but can be damaged by sharp finger nails. A tiny perforation on the suction side of the pump will let in air and prevent the pump drawing water.
- The tubing around the pump must be replaced periodically, typically every three months but this varies with use. See page 9 for details.

Condensation

It is normal for some condensation to occur on the cooler exposed parts of the clear top. This natural phenomenon is not a hazard or a problem for incubation but may indicate the room is cooler than optimum.

SETTING THE DAY COUNTDOWN

The day countdown may be set to the correct number of days for the particular species of egg being incubated. If the turning system is in automatic mode (see page 20) the eggs will stop being turned 2 days before the eggs are due to hatch. Note that if the eggs have already been incubated by the parent bird the number of days should be reduced accordingly.



1. Press the - and + buttons simultaneously to unlock the Main Menu.



2. Press + to scroll to the DAY countdown option



3. Press OK to select the day countdown screen and adjust as necessary using the + and - buttons e.g. hens 21, ducks 28.



4. Press OK to return to the Main Menu and then scroll down to SAVE. Press OK to save the changes.

EGG STORING

Ensure that you store eggs in cool, damp conditions. Most species may be safely stored for up to 14 days before serious reductions in hatch rates are likely. Daily turning of stored eggs also helps maintain hatchability.

Cracked, mis-shaped and heavily soiled eggs should be discarded (if possible). It is not recommended that eggs for incubation are washed as this will remove the outer cuticle from the egg as well as the dirt and may leave the egg at greater risk from bacterial contamination. However soiled eggs can add contaminants that are damaging to growing embryos in the egg, so if cleaning is the only option a specialist egg wash solution should be used following the manufacturer's instructions.

EGG SETTING

Before setting eggs ensure that the incubator has been running for several hours and has stabilised at the correct temperature.

The Mini II EX Connect is designed to accommodate eggs of different sizes. Quail, hen, large duck and goose eggs are accommodated in the egg quadrants provided.

Set the eggs in the pockets of the egg quadrants provided. The eggs need to be set lying flat and most eggs favour being set with their pointed ends facing inwards towards the middle of the egg quadrant. Some experimentation may be required to check which direction gives the most even turning.

Eggs should rest so that their pointed end is down most of the time. This will happen more naturally as the air space gets larger during incubation. If a particular egg is tending to rest point upwards turn it round to face the other way in the pocket on the egg quadrant. Ensure the eggs are clean around their middle as large pieces of dirt may prevent them turning correctly.

Switch the turning system on – see section 10. A revolving line symbol “/” should be shown in the corner of the display.

Once the eggs have been set the temperature must not be adjusted for 24 hours to allow the eggs to warm. Check the water level every 3 days or so and temperature daily. Candle the eggs after 1/3rd of the incubation period has elapsed to reject clear, infertile eggs.





Eggs set lying flat with their pointed ends facing inwards towards the middle of the egg disc

7 EGGS

SETTING THE TURNING OPTIONS

- 

1. Press the - and + buttons simultaneously to unlock the Main Menu.
- 

2. Press + to scroll to the TURN Off/Aut/On option.
- 

3. Press OK to select the turning mode screen and use the + and - buttons to set to ON or OFF as required.
- 

4. Press OK to return to the Main Menu. The TURN INT option will now be displayed. Press OK to select the turn interval screen and use the + and - buttons to set the delay between turns in minutes as required.
- 

5. Press OK to return to the Main Menu. The TURN ANG option will be displayed. Press OK to select the turn angle screen and use the + and - buttons to set the turning angle timer as appropriate for the size of the eggs.
- 

6. Press OK to return to the Main Menu and then scroll down to SAVE. Press OK to save the changes.

TURNING EGGS

The Mini II EX Connect turning system has three modes of operation:

ON – The turning system will alternately roll the eggs left and right irrespective of the Day Countdown. A revolving line symbol “/” is shown in the corner of the display.

AUTO – The turning system will alternately roll the eggs left and right until the Day Countdown reaches 2. Turning will then automatically be switched to OFF and an “O” will flash with the revolving line symbol “/” in the corner of the display.

OFF – The turning system is switched off irrespective of the Day Countdown. This is used for hatching purposes. An “O” will flash in the corner of the display.

The length of time interval between turns may be adjusted and the angle the eggs are turned through may also be adjusted to suit different size eggs. The turning motor runs for a set time and this time (in seconds) can be adjusted to achieve the appropriate turn angle for the eggs.

Larger eggs will require a longer turn to achieve the same angle as smaller ones. Use the chart below for a simple guide. Match the TURN ANG setting to the diameter of the eggs. This should give a turn angle of between 90 and 120 degrees.

If eggs of mixed sizes are being incubated it will be necessary to compromise the turning angle. In general, if the larger eggs turn through 90 degrees (1/4 of a turn) then the smaller ones may turn through twice this with no problem. Parrot like species may benefit from larger turns in the first 10 days of incubation.

If eggs are set in both circles of pockets on the egg quadrants the outer circle of eggs will turn through a greater angle. This will not be a problem, adjust the turning angle so that the inner circle of eggs turns through 90 degrees (1/4 of a turn).

The turn interval may be set to approximately one hour for most species but parrots' eggs benefit from more frequent turns with 5- or 10-minute intervals for the first 10 days of incubation.

Remember to stop the turning 2 days before the eggs are due to hatch.

Match the 'TURN ANG' setting (seconds) to the diameter of the eggs in the diagram below

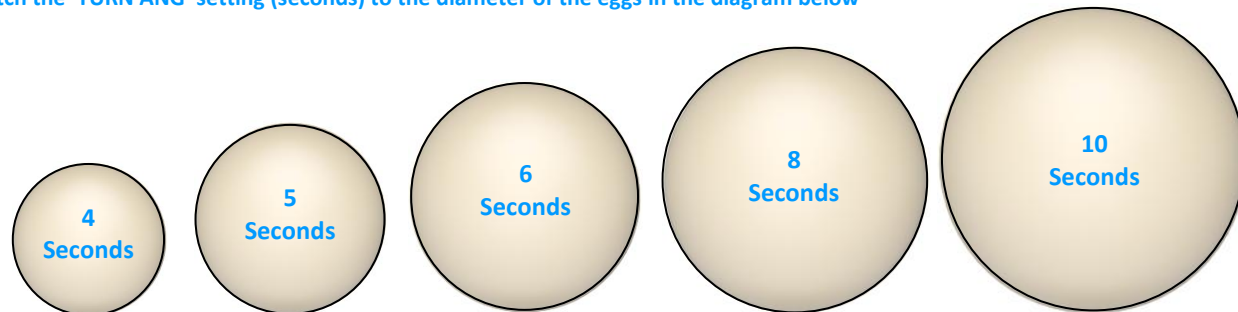

8 PERIODIC INCUBATION COOLING

SETTING THE COOLING PERIOD

The cooling function is not essential. It's an optional feature that may be adjusted for breeders wishing to experiment. The factory default is set to "cooling OFF". **Do not use before day 7 of incubation or whilst hatching.**



1. Press the - and + buttons simultaneously to unlock the Main Menu.



2. Press the + button to scroll to the cooling option.



3. Press OK to select the cooling screen. Use the + and - buttons to select OFF or 10 to 360 minutes of cooling.



4. Press OK to accept the figure and then scroll to SAVE and press OK to save the changes.



BACKGROUND INFORMATION ON PERIODIC COOLING

The precise details of which days and what cooling period each day should be used for best effect are not known. Brinsea have assessed the available research and suggest that poultry, water fowl and game bird eggs have a 30 minute daily cooling period from day 7 through to 2 days before eggs are due to hatch (the same point that automatic turning would normally be stopped).

COOLING IS NOT RECOMMENDED FOR PARROTS AND BIRDS OF PREY BECAUSE THE RESULTS OF COOLING HAVEN'T YET BEEN ESTABLISHED. For further details please visit the Brinsea website at www.brinsea.co.uk/cooling

HOW IT WORKS WITH YOUR INCUBATOR

- The periodic cooling feature turns the incubator's heater and low temperature alarm off for a selectable period but keeps the fan running. After the cooling period is complete the incubator reverts to normal temperature and the alarm is automatically reset.
- Each cooling period starts at approximately the same time each day (24 hours between start times). The first cooling period will start 24 hours after the incubator was last switched on. If there is a power interruption the 24 hour delay starts again.
- During the cooling period the heater asterisk goes off and an arrow "↓" is displayed. When the cooling period ends the asterisk is shown and the incubator warms to incubation temperature. The time taken to return to incubation temperature depends on the room temperature and may take 30 or more minutes.
- The humidity pump will not run during periodic cooling; humidity levels will rise as the air cools.

9 HATCHING & CLEANING UP

HATCHING

1: If hatching in the Mini II EX Connect, make sure turning is switched to OFF in the control menu two days before the hatch is due.

2: Remove the top, take out the egg disc and insert the hatching mat into the base two days before the hatch is due. Lay the eggs directly onto the mat. Don't re-use hatching mats. Replacements are available from brinsea.co.uk, brinsea.com or your local stockist (product code 14.901).

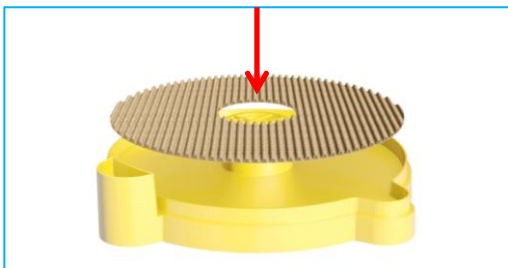

3: Put the top back on.

Hatching humidity levels need to be high (see section 6 above).

When most eggs have hatched (12 to 48 hours after the first egg hatches) remove the hatchlings to a brooder. The Brinsea EcoGlow 600 and 1200 are ideal for poultry and waterfowl etc. The Brinsea TLC-40 and TLC-50 Brooders are recommended for exotics.

During hatching the high humidity levels will fall dramatically when the lid is lifted and will take some time to build up. Resist the temptation to open the incubator frequently – leave for at least 6 hours between inspections.

CLEANING UP

IMPORTANT:

DISCONNECT THE INCUBATOR FROM THE MAINS POWER SUPPLY DURING CLEANING.

ENSURE THAT ALL ELECTRICAL PARTS ARE KEPT DRY. DO NOT IMMERSE THE INCUBATOR TOP.

NEVER WASH THE BASE, EGG DISCS, COVERS OR CABINET PARTS IN LIQUIDS OVER 50°C (120°F). DO NOT USE A DISHWASHER TO CLEAN ANY PARTS OF THE INCUBATOR.

Following each hatch in the Mini II EX Connect remove and wash the egg disc and base in a water-based disinfectant solution (diluted according to the manufacturer's recommendations) and then rinse thoroughly. Use a vacuum cleaner and soft brush to remove dust from the fan guard. Wipe all other internal surfaces with a cloth made damp with the solution and then wipe off with a cloth made damp with clean water. Ensure that the instructions supplied with the fluid are followed.

If a separate hatcher is used the procedure above should still be followed every two months.

The exterior of the incubator may be cleaned with a damp cloth. Avoid allowing any moisture to get inside electrical housings.

Periodically unscrew the four screws retaining the fan guard, remove the cover and soak. Dust and fluff may be removed from the fan and heater cord with a soft brush. USE NO LIQUIDS. DO NOT TURN THE LID OVER AS THE FAN IS NOT FIXED ONCE THE FAN COVER IS REMOVED. The fan must be located on the 4 pegs under the lid with its label facing into the lid before the cover is re-fitted. DO NOT OVER-TIGHTEN THE SCREWS.

ALWAYS CLEAN THE INCUBATOR BEFORE STORAGE AND ENSURE THAT THE UNIT IS TOTALLY DRY INSIDE AND OUT. ALLOW IT TO RUN FOR 24 HOURS WITH NO WATER IN TO ENSURE IT IS THOROUGHLY DRY.

TROUBLE-SHOOTING AND CALIBRATION

In case of failure first check that the mains power supply is working and that the mains cable connector is fully engaged in the socket on the control enclosure.

The digital temperature and humidity display is individually calibrated during manufacture but may be re-calibrated if required. In the unlikely event that your hatching success makes you doubt the temperature or humidity calibration of your machine please contact your distributor or Brinsea directly at sales@brinsea.co.uk for further information and advice.

10 SPECIFICATIONS

MINI II MAXIMUM SETTING CAPACITIES:

Egg size	Typical capacity
Quail	12
Pheasant	12
Hen	7
Duck	7

Dimensions: 245mm x 245mm x 165mm

Weight: 1.217 Kg

Power Consumption:

Incubator maximum (typical average) 20 Watts
12 Watts

Electrical Supply: 100 - 230v, 50/60Hz, 0.5A max.

Radio frequency band: 2.4GHz Wi-Fi
Channels 1 – 11 only

Maximum equivalent isotropically radiated power: 2412 – 2462 MHz
13.66 dBm

7 hen eggs
Standard egg disc



12 quail eggs
Small egg disc



7 duck eggs
Standard egg disc



12 pheasant eggs
Small egg disc



Used electrical and electronic products should not be mixed with general household waste. For proper treatment, recovery and recycling, please take this product to a designated collection point where it will be accepted free of charge.

Please contact your local authority for further details of your nearest designated collection point.

Disposing of this product correctly will help save valuable resources and prevent any potential negative effects on human health and the environment, which could otherwise arise from inappropriate waste handling.

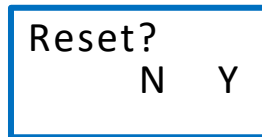

Your home Wi-Fi ID and password may be cleared from the incubator by holding the OK button and connecting the power lead. The control panel on the incubator will show "Reset?" when ready to clear the data. Press the + button (Y) to reset all factory defaults and clear the Wi-Fi details.

To remove your personal data from the app and server, tap Delete Account in the app Options page.

Registered Community Design Application No 003007103

Brinsea Products Ltd, 32-33 Buckingham Road, Weston Industrial Estate,
Weston-super-Mare, N. Somerset, BS24 9BG
Tel: +44 (0) 345 226 0120
e-mail: support@brinsea.co.uk, website: www.brinsea.co.uk

Declaration of Conformity

We: BRINSEA PRODUCTS LTD.
32-33 Buckingham Road
Weston Industrial Estate
Weston-super-Mare
North Somerset
BS24 9BG

Declare under our sole responsibility the products:

Egg Incubators:

Mini II EX Connect (Serial Numbers AB19x/xxxxxxxx)

to which this declaration relates are in conformity with the following UK regulations:

Radio Equipment Regulations 2017

The Restriction of the Use of Certain Hazardous Substances in Electrical and Electronic Equipment Regulations 2012

The relevant sections of the following Standards have been used:

BS EN 60335-1:2012+A15:2021
BS EN 60335-2-71:2003+A1:2007
BS EN 55014-1:2017+A11:2020
BS EN 55014-2:2015
ETSI EN 300 328 V2.2.2
BS EN 62479:2010
EN 18031-1:2024
BS EN 63000:2018

The technical documentation for the products is available from the above address.

Authorised Representative: Ian Pearce, Managing Director

Signature:

Date of Issue: 18 November 2025

Place of Issue: 32-33 Buckingham Road, Weston Industrial Estate,
Weston-super-Mare, North Somerset, BS24 9BG, United Kingdom.

CE EU Declaration of Conformity

In accordance with European Parliament and Council
Decision No 768/2008/EC Annex III

1. Product model / product:

Product: Egg incubators
Model: Mini II EX Connect (Serial Numbers AB19x/xxxxxxxx)

2. Manufacturer:

Name: Brinsea Products Ltd.
Address: 32-33 Buckingham Road, Weston Industrial Estate,
Weston-super-Mare, BS24 9BG, England

Authorised Representative:

Name: Authorised Rep Compliance Ltd.
Address: Ground Floor, 71 Lower Baggot Street, Dublin, D02 P593, Ireland

3. This declaration is issued under the sole responsibility of the manufacturer.

4. Object of the declaration:

Product: Mini II EX Connect egg incubators
Specification: Power supply 230V, Class III appliance 12V dc, 1.5A, capacity 7 eggs.

5. The object of the declaration described above is in conformity with the relevant EU harmonisation legislation:

2014/53/EU Radio Equipment Directive
2011/65/EU Restriction on the use of certain hazardous substances (RoHS)

6. References to the relevant harmonised standards used or references to the other technical specifications in relation to which conformity is declared:

EN 60335-1:2012+A15:2021
EN 60335-2-71:2003+A1:2007
EN 55014-1:2017+A11:2020
EN 55014-2:2015
ETSI EN 300 328 V2.2.2
EN 62479:2010
EN 18031-1:2024
EN IEC 63000:2018

7. The technical documentation for the product is available from the authorised representative at the address above.

Signed for and on behalf of: Brinsea Products Ltd.
Place of issue: Weston-super-Mare
Date of issue: 18 November 2025
Name: Ian Pearce
Function: Managing Director
Signature:

Statement of Compliance

Product:

Egg Incubators:

Mini II EX Connect (Serial numbers AB19x/xxxxxxxx)

Name and address of manufacturer:

BRINSEA PRODUCTS LTD.
32-33 Buckingham Road
Weston Industrial Estate
Weston-super-Mare
North Somerset
BS24 9BG

This declaration of compliance is prepared by the manufacturer of this product.

We, the manufacturer, declare that in our opinion we have complied with:

The Product Security and Telecommunications Infrastructure (Security Requirements for Relevant Connectable Products) Regulations 2023 – Schedule 2

The relevant sections of the following Standards have been used:

ETSI EN 303 645 V2.1.1 (issued 2020-06) (provision 5.1-1, 5.1-2, 5.2-1, 5.3-13)

The defined support period for the product is one year.

Signed for and on behalf of the manufacturer:

Name: Ian Pearce,

Function: Managing Director

Signature:

Date of Issue: 18 November 2025

Place of Issue: 32-33 Buckingham Road, Weston Industrial Estate, Weston-super-Mare, North Somerset, BS24 9BG, United Kingdom.