

# **Brinsea**

## **OVA-EASY 190 and 380 ADVANCE**

### **User Instructions**

#### Contents

Section	Subject	Page
1	Introduction	2
2	Unpacking	3
3	Location and Installation	3
4	Quick Reference	3
5	Digital Control System	5
6	Storage of eggs	7
7	Temperature	7
8	Humidity and Ventilation	8
9	Egg Turning	10
10	Egg Setting	11
11	Periodic Incubation Cooling	12
12	Hatching	12
13	Cleaning up	13
14	Troubleshooting	13
15	Servicing and Calibration	15
16	Specifications	17

# 1 Introduction



**Read the instructions before use.**

These instructions detail the operation of your new 190 or 380 egg Digital Cabinet Incubator with programmable automatic egg turning system. Please read these instructions carefully before setting up your machine to achieve best results and keep these instructions safe for future reference. This document includes recommended procedures for successful hatching but incubation involves the control and manipulation of a large number of factors and in certain circumstances different procedures may be necessary. Your incubator is designed to allow the user to vary the incubation conditions to suit a wide range of species in different ambient conditions and the specific set-up for every situation is beyond the scope of these instructions.

There is a range of books available covering incubation techniques, for more information or to request a book list please don't hesitate to contact us.

The Ova-Easy Advance incubators are available with the option of the Advance Humidity Pump for automatic humidity control. Operating instructions for this module are supplied separately.

**Fig. 1 Functional Features of the Ova-Easy 190 and 380 Advance Cabinet Incubators with Programmable Automatic Turning.**

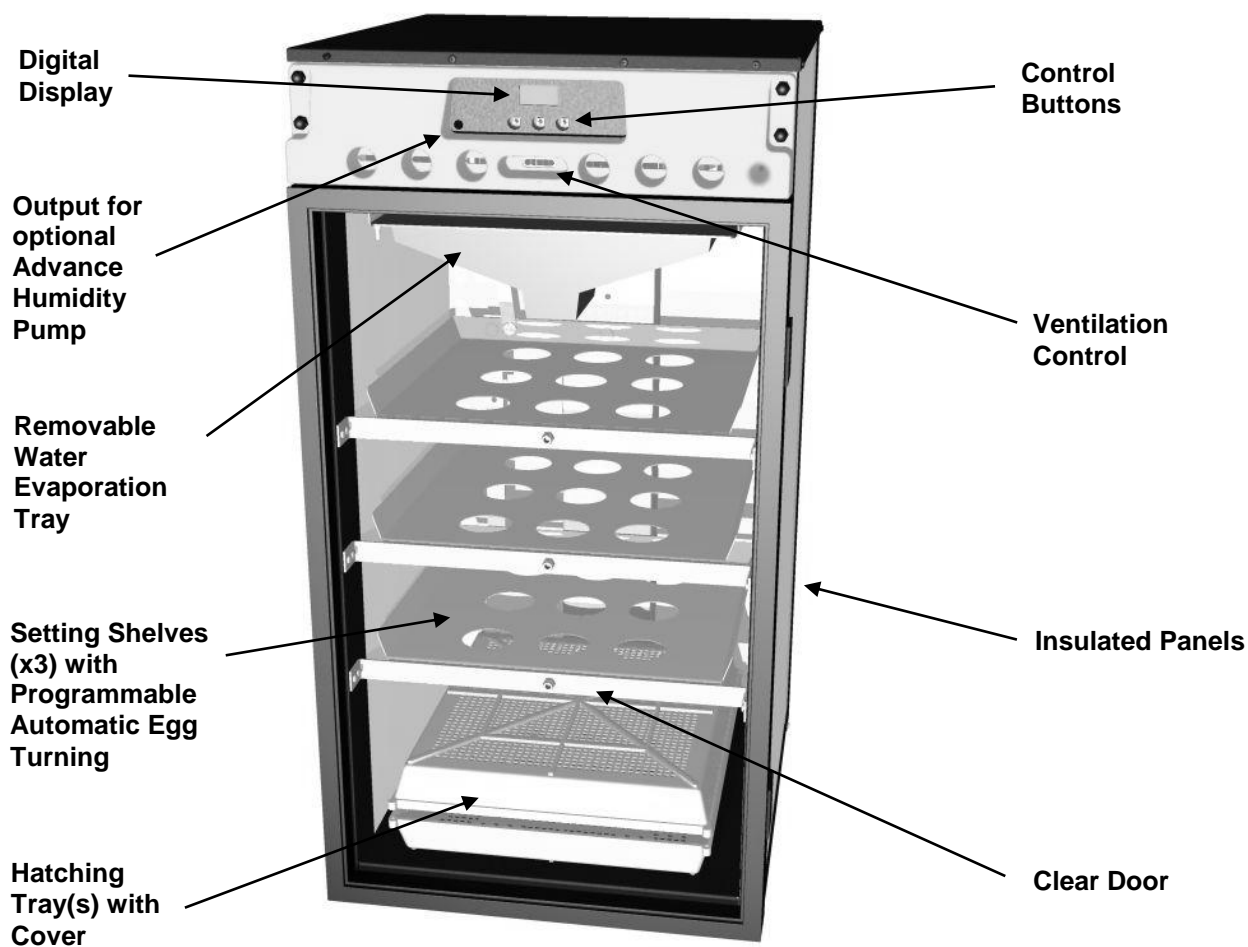

## 2 Unpacking & Assembly

- 2.1 Your incubator has been supplied in protective packaging. Please remove all tape, strapping and packing from the incubator parts. Retain the carton and packing materials to enable the unit to be repacked.
- 2.2 Please check that parts are all present and undamaged. **Damaged appliances shall not be used.**
- 2.3 Check also that the electrical supply matches the machine's requirements (marked on the technical label on the outside of the box and on the top cover of the Incubator). The power cord set must be an appropriately rated and approved cord-set in accordance with the regulations of the country it is used in.
- 2.4 To register your new Brinsea product please visit [www.brinsea.co.uk](http://www.brinsea.co.uk) and follow the link on the right hand side of the home page to qualify for your free 2 year guarantee.
- 2.5 Go to [www.Brinsea.co.uk](http://www.Brinsea.co.uk) and register as a free member of the Brinsea Email Group to receive the latest news and information such as advance notice about new products, special offers, exclusive competitions and much more.





## 3 Location and Installation

**THE INCUBATOR MUST BE PLACED IN AN INDOOR AREA NOT SUBJECT TO SPLASHES OF WATER OR WET CONDITIONS AND OUT OF REACH OF ANIMALS AND CHILDREN.**

- 3.1 Your incubator will give best results in a room free from wide temperature variations and with generous ventilation – particularly if several incubators are running at the same time. Ensure that the room temperature cannot drop on a cold night. Ideally thermostatically control the room at between 20 and 25°C (68 and 77°F). Never allow the room temperature to drop below 15°C (59°F) and ensure that the incubator cannot be exposed to direct sunlight.
- 3.2 Always place the incubator upright on a flat level surface off the floor. The 190 size incubator weighs 20Kg and the 380 size incubator weighs 27Kg. Ensure the surface is adequate to support the weight of the machine and contents.
- 3.3 Open the door, slide out the Evaporation Tray and fill with 1:200 mix of water and Brinsea disinfectant solution. The water level should be no higher than approx 1" (2.5cm) from the top. The evaporating block is not normally needed unless very high humidity levels (e.g. for hatching) are required or the optional Advance Humidity Pump is being used. Close the door.
- 3.4 Plug the incubator supply cable into a suitable outlet ensuring that the cable is not pulled tight. The incubator fans will start, the buzzer sound and the LCD display will show the air temperature and humidity.

## 4 Quick Reference (please read relevant section for detail)

This quick reference is intended to allow users to quickly set up the incubator and learn the key features of the control system. Please read the rest of the instructions to obtain a full understanding of each feature.

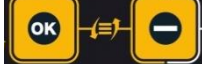
	PRESS BOTH BUTTONS TO UNLOCK THE MAIN MENU
	SELECT THE OPTION / RETURN TO THE MENU.
	GO FORWARD ONE SCREEN / INCREASE THE VALUE / DISPLAY IN CELSIUS.
	GO BACK ONE SCREEN / DECREASE THE VALUE / DISPLAY IN FAHRENHEIT.
	PRESS BOTH BUTTONS TO TURN NOW (THEN ANY BUTTON TO PAUSE / STOP)

MAIN MENU – QUICK REFERENCE

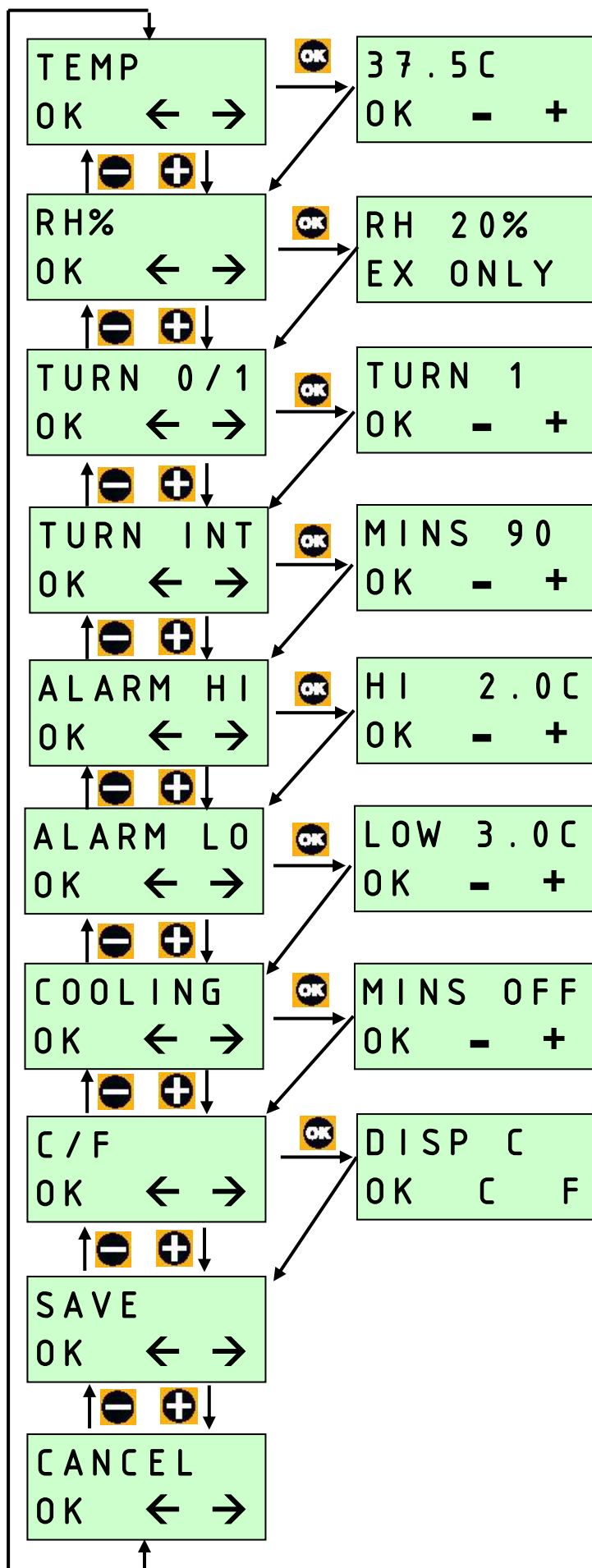

**INCUBATION TEMPERATURE.**  
 RANGE 20.0 – 40.0°C (68.0 – 104.0°F).  
 DEFAULT 37.5°C (99.5°F).

**RELATIVE HUMIDITY.**  
 RANGE 20% – 80%.  
 DEFAULT 20%.  
 ONLY FOR EX VERSION WITH  
 ADVANCE HUMIDITY PUMP – SEE  
 SECTION 8.

**AUTOMATIC TURNING STATUS.**  
 SWITCHES THE AUTOMATIC  
 TURNING SYSTEM ON (1) OR OFF (0).  
 DEFAULT OFF (0).

**TURNING INTERVAL.**  
 SETS THE DELAY BETWEEN TURNS.  
 RANGE 30 – 180 MINUTES.  
 DEFAULT 45 MINUTES.

**HIGH TEMPERATURE ALARM.**  
 RANGE 1.0 – 5.0°C (1.8 – 9.0°F) ABOVE  
 SET INCUBATION TEMPERATURE.  
 DEFAULT 2.0°C (3.6°F).

**LOW TEMPERATURE ALARM.**  
 RANGE 1.0 – 5.0°C (1.8 – 9.0°F) BELOW  
 SET INCUBATION TEMPERATURE.  
 DEFAULT 3.0°C (5.4°F).

**PERIODIC INCUBATION COOLING.**  
 SWITCHES HEATER OFF FOR A  
 TIMED PERIOD ONCE EVERY 24  
 HOURS (SEE SECTION 11).  
 RANGE 60 – 360 MINUTES.  
 DEFAULT - OFF.

**CELSIUS / FAHRENHEIT DISPLAY.**  
 SWITCHES ALL TEMPERATURE  
 FIGURES BETWEEN °C AND °F.  
 DEFAULT °C.

**SAVE.**  
 ALL CHANGES ARE SAVED. RETURN  
 TO NORMAL OPERATION SCREEN.

**CANCEL.**  
 ALL CHANGES ARE IGNORED.  
 RETURN TO NORMAL OPERATION  
 SCREEN.

## 5 DIGITAL CONTROL SYSTEM

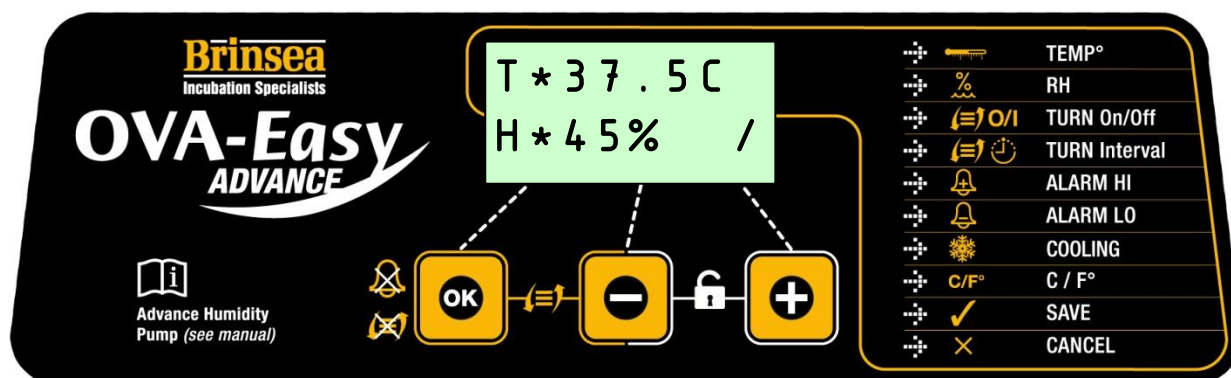

The Ova-Easy Advance control system utilises highly accurate, individually calibrated sensors for temperature and humidity. Be cautious of low cost analogue or digital thermometers and hygrometers when comparing them with the incubator display readings.

- 5.1 **NORMAL OPERATION** – Temperature and relative humidity are continuously displayed. Turning status indicator shows if automatic turning is switched on or off.

The asterisk "\*" adjacent to the temperature reading shows when the heater power is on. When warming the asterisk will be continuously on, once warmed up the asterisk will slowly flash as the heater is pulsed to maintain the correct temperature.

When reducing the temperature setting the asterisk may go off, this is normal. During periodic incubation cooling (see section 11) the asterisk will be replaced by an arrow: "↓".

The asterisk "\*" adjacent to the relative humidity display is only on when the pump control output is on (see section 8) and is only applicable when using the optional Brinsea Advance Humidity Management Module.

If automatic turning is switched off "=" is shown in the corner of the display.

If automatic turning is switched on a line "/" symbol is shown revolving in the corner of the display.

- 5.2 **POWER LOSS DISPLAY** – If power has been interrupted due to a power cut (or when first switching on) a "P" is shown flashing on the bottom line of the display. Press OK for 2 or more seconds to clear the indicator. If the reason for the power loss is not known check the power cable connections are secure.

Once the "P" indicator has been cleared, it is advisable to candle eggs a number of times to check for losses.

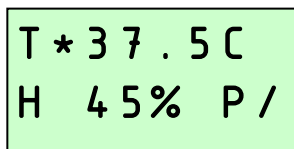

- 5.3 HIGH TEMPERATURE ALARM DISPLAY – If the measured temperature goes up by more than the figure in the ALARM HI screen, the alarm will sound immediately and “+T” will be displayed. Press OK to silence the alarm for 30 minutes.

If the high temperature problem rectifies itself the “+T” remains on the display to show this has happened. Press OK to clear the indicator. Check the incubator is not (and has not been) in direct sunlight or too near a heat source such as a room heater. It is advisable to candle eggs a number of times after this event to check for losses.

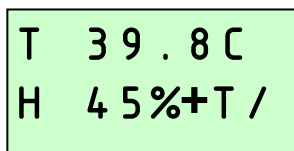

T 39.8 C  
H 45%+T /

- 5.4 LOW TEMPERATURE ALARM DISPLAY – If the measured temperature goes down by more than the figure in the ALARM LO screen, after 60 minutes “-T” will be displayed and the alarm will sound. Press OK to silence the alarm for 30 minutes.

If the low temperature problem rectifies itself the “-T” remains on the display to show this has happened. Press OK to clear the indicator. Check the incubator is not (and has not been) in a cold draught or that the room temperature has dropped significantly. It is advisable to candle eggs a number of times after this event to check for losses.

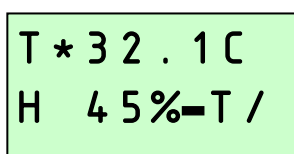

T \* 32.1 C  
H 45%-T /

- 5.5 TURN SYSTEM PAUSE DISPLAY. (Please refer to section 9 for details)

**TO PREVENT THE RISK OF POSSIBLE INJURY OR DAMAGE TO THE MECHANISM NEVER INITIATE A TURN WITH THE DOOR OPEN.**

**DO NOT OPEN THE DOOR WHILE THE SHELVES ARE MOVING. AN ALARM SOUNDS AT THE START OF EACH TURN TO WARN THE OPERATOR. THE SHELVES MAY BE STOPPED BY PRESSING ANY BUTTON ONCE.**

A turn may be initiated at any time by pressing buttons OK and - . The shelves may then be stopped in any position (e.g. level to allow removal of the trays) by pressing any button. The turn is left in one of two states depending on whether automatic turning is set on or off:-

If automatic turning is set to on (1) in the Main Menu the current turn is "paused". It may be restarted again by pressing any button. If it is not restarted within 30 minutes an alarm sounds to remind the operator. This function is useful for inspecting eggs.

If automatic turning is set to off (0) in the Main Menu then the current turn is cancelled. The shelves remain fixed in their current position. This function is useful for using the incubator as a hatcher.

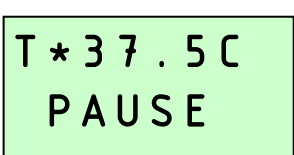

T \* 37.5 C  
PAUSE

- 5.6 **TURN SYSTEM FAULT ALARM** - If the shelves become jammed by debris or incorrectly loaded trays the motor is switched off and an alarm sounds. The display shows "FAULT". Automatic turning is also temporarily set to off (0) in the Main Menu to prevent the turn restarting. **Always check trays are loaded to the back of each shelf as damage may occur if the shelves are jammed by trays placed too far forward.**

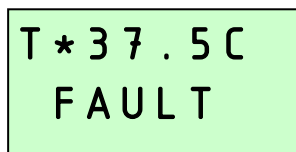

- 5.7 **CHANGING SETTINGS** – The Main Menu allows the various settings to be modified and saved. All changes are retained in the event of a power cut.

To access the Main Menu press the + and – buttons simultaneously to unlock the display. For full details of menu settings please refer to the guide on page 4.

## 6 Storage of eggs

- 6.1 Store eggs in cool, damp conditions. Most species may be safely stored for up to 14 days before serious reductions in hatch rates are likely. Daily turning of stored eggs also helps maintain hatchability.
- 6.2 Discard cracked, mis-shaped and heavily soiled eggs (if possible). Only wash soiled eggs using a brand egg wash solution following the manufacturer’s instructions. It is essential to wash eggs in solution which is significantly warmer than the egg. Bear in mind that all solutions will remove the outer cuticle from the egg as well as the dirt and may leave the egg at greater risk from bacterial contamination in the future.

## 7 Temperature

**Stable and correct temperature is essential for good results. Adjust with care.**

- 7.1 Note: your incubator may not be set to the correct temperature from the factory and the following procedure must be followed before setting eggs.
- 7.2 As the incubator warms up and approaches its control setting the heater on asterisk “\*” will change from continuously on to flashing. Allow the incubator to stabilise for at least an hour before adjusting the temperature.

### 7.3 SETTING THE TEMPERATURE

Press the - and + buttons simultaneously to unlock the Main Menu.

Press OK to select the temperature screen and adjust as necessary using the + and – buttons.

Press OK to return to the Main Menu and then scroll down to SAVE. Press OK to save the changes.

When reducing temperature the asterisk may go out while the incubator cools – this is normal.

- 7.4 Refer to the digital temperature display to check temperature. The display shows the air temperature in increments of 0.1°. Adjust temperature with care – small differences have large effects on hatching performance.
- 7.5 The Display can be switched to show all temperature settings in degrees Fahrenheit. Press the - and + buttons simultaneously to unlock the Main Menu. Scroll to the C/F option and press OK to select the C/F display screen. Press the + button to select °F or the – button to select °C. Press OK to return to the Main Menu and then scroll down to Save. Press OK to save the changes.

7.6	Recommended temperatures:	Typical incubation period:		
	Hens	37.4 – 37.6°C	99.3 – 99.6°F	21 days
	Pheasant	37.6 – 37.8°C	99.6 - 100°F	23-27 days
	Quail	37.6 – 37.8°C	99.6 - 100°F	16-23 days
	Ducks	37.4 – 37.6°C	99.3 – 99.6°F	28 days
	Geese	37.4 – 37.6°C	99.3 – 99.6°F	28-32 days

7.7 Developing embryos are fairly tolerant of short term temperature drops and the user need not be concerned about cooling that occurs when inspecting eggs. Temperatures above ideal can quickly have a serious detrimental effect on hatch rates and must be avoided.

7.8 Ova-Easy Advance incubators have a built-in temperature alarm which warns of high or low temperatures. See section 5 for details.

## 8 Humidity and Ventilation

Short term variations in humidity are not important. The average humidity over the incubation period needs to be near optimum to achieve the ideal weight loss. High humidity for the day or two of hatching is also important. Beware chronic, excessive humidity.

Two main factors affect incubation humidity: water evaporation within the cabinet (from eggs as well as from additional water) and levels of ventilation. The water content of the air being drawn through the incubator will also have an effect.

There are two methods available to bird breeders to achieve correct humidity levels in the Ova-Easy Advance:

8.1 Monitor humidity levels and adjust to match published guidelines for different species.

Generally accepted incubation RH levels for species groups:

During incubation	Poultry	40-50% RH
	Waterfowl	45-55% RH
Hatching	All species	60% RH or more

For more specific information on particular species' requirements check the relevant literature.

8.2 Monitor egg weight loss which varies as a direct result of humidity and correct against published weight loss figures for the species.

Eggs lose moisture through their shells and the rate of evaporation depends on the humidity levels around the eggs and the shell porosity. During incubation eggs need to lose a fixed amount of water which corresponds to a loss in weight of around 13-16% depending on species. By weighing eggs periodically during incubation it is possible to monitor and, if necessary, correct humidity levels to achieve the correct weight loss.

Weigh the eggs on the day they are set in the incubator, take the average weight and plot this on a graph (see example below). The ideal weight loss line can be plotted by joining the point representing initial average weight with the ideal hatch weight (13-16% less depending on species) with the x-axis representing the incubation period (in days).

By measuring actual average weights every few days the actual weight loss can be plotted and compared to the ideal weight loss line and corrections can be made. For example if the actual weight loss was greater than ideal (see graph below) then the air has been too dry and humidity levels need to be increased to compensate.



Typical ideal weight losses for species groups:

Poultry	13%
Waterfowl	14%

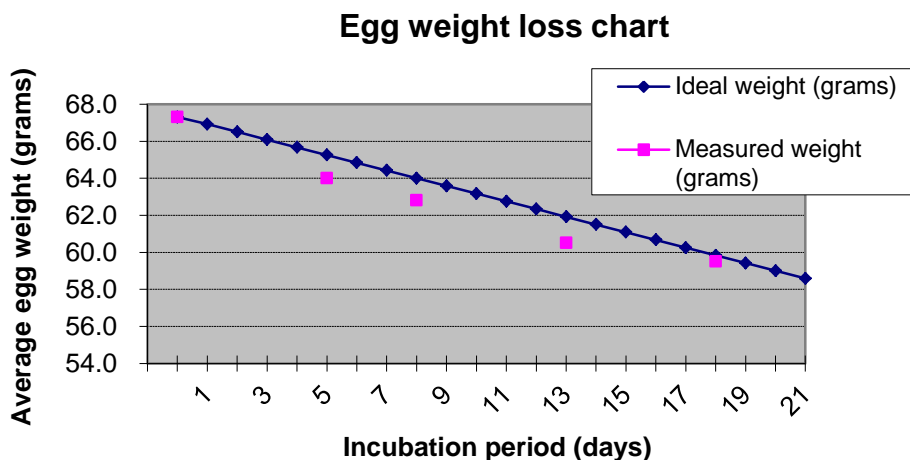

Of the two methods given above the most reliable is egg weight method and is recommended – particularly where poor hatch rates are experienced or if eggs of high value are being incubated.

Alter the setting of the ventilation control (reduce ventilation to increase humidity) and add water to the evaporation tray to change the humidity level. Humidity levels may be further increased by fitting the evaporation block as shown.

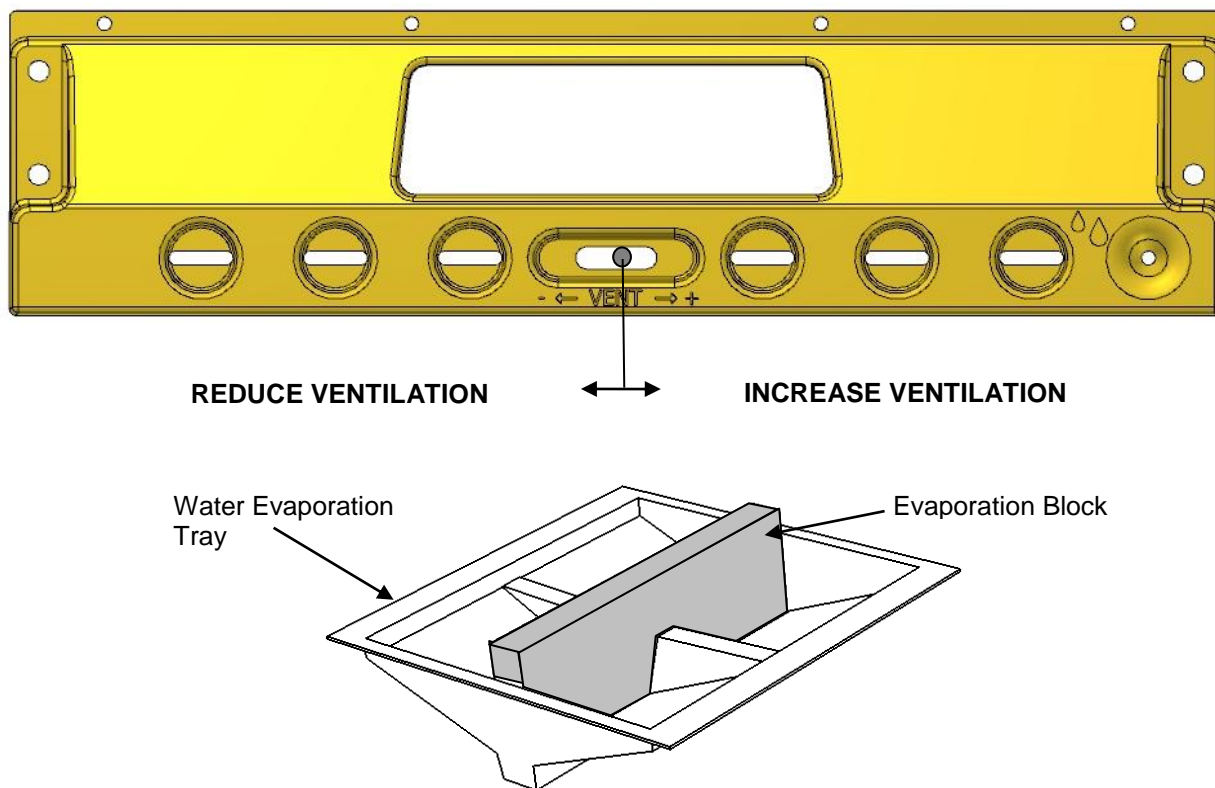

8.3 In all cases the humidity for hatching needs to be high. Because of the short duration involved water/weight loss will not be significantly affected. High humidity is necessary to prevent membranes drying and hardening before the hatch fully emerges. Humidity will naturally increase as the first eggs begin to hatch and internal membranes begin to dry. This effect is in addition to the increased area of water evaporation from the evaporation block.

- 8.4 During hatching the high humidity levels will fall dramatically when the door is opened and will take some time to build up. Resist the temptation to open the door frequently – leave for at least 6 hours between inspections.
- 8.5 The Brinsea Advance Humidity Pump is available as an option on the Ova-Easy Advance incubators. The incubator digital control system not only reads the humidity in the incubator but it provides a control signal to operate the water pump and accurately maintain the humidity level at the desired level. Visit [www.brinsea.com](http://www.brinsea.com) for more information.

## 9 Egg Turning

The turning system has two modes of operation:

Automatic turning can be switched on for “multi-stage incubation” where the shelves are used for incubating eggs and the hatching tray is used for the hatching of the eggs.

Automatic turning can be switched off for using the whole incubator to hatch eggs.

### 9.1 SWITCHING AUTOMATIC TURNING ON AND OFF

Press the - and + buttons simultaneously to unlock the Main Menu.

Scroll to the TURN 0 / 1 option and press OK to select the Turn on/off screen.

Press the + button to switch turning on (1) or the – button to switch turning off (0).

Press OK to return to the Main Menu and then scroll down to SAVE. Press OK to save the changes.

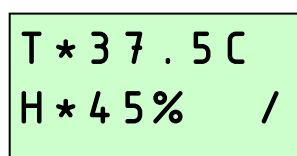

Automatic turning is ON

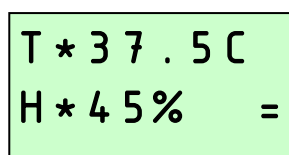

Automatic turning is OFF

### 9.2 SETTING THE TURN DELAY INTERVAL

Press the - and + buttons simultaneously to unlock the Main Menu.

Scroll to the TURN INT option and press OK to select the Turn interval screen.

Press the + button to increase and the - button to decrease the turn delay interval between 30 and 180 minutes in increments of 15 minutes.

Press OK to return to the Main Menu and then scroll down to SAVE. Press OK to save the changes.

### 9.3 STARTING A TURN

**TO PREVENT THE RISK OF POSSIBLE INJURY OR DAMAGE TO THE MECHANISM NEVER INITIATE A TURN WITH THE DOOR OPEN.**

**DO NOT OPEN THE DOOR WHILE THE SHELVES ARE MOVING. AN ALARM SOUNDS AT THE START OF EACH TURN TO WARN THE OPERATOR. THE SHELVES MAY BE STOPPED BY PRESSING ANY BUTTON ONCE.**

A turn may be started at any time regardless of whether automatic turning is switched on or off. This may be to check the system or to level the shelves to access the trays.

Press the OK and - buttons simultaneously. The alarm will sound and the shelves will start to turn. **Always ensure the shelves are free of obstructions and the door is closed during turning.**

The motor may make a “clacking” sound when it starts. This is the anti-reversing mechanism operating and is perfectly normal.

#### 9.4 STOPPING A TURN TO LOAD THE SHELVES (OR USE ALL SHELVES FOR HATCHING)

Press any button to stop a turn. This is useful to stop the shelves once they are level for loading trays and for when the whole incubator is to be used for hatching eggs.

If automatic turning is ON the turn will PAUSE to allow trays to be loaded. Once the trays are loaded and the door is shut press any button to continue the turn. If the turn isn't re-started within 30 minutes an alarm sounds to remind the operator. The turn system will not re-start itself.

If automatic turning is OFF the turn will be cancelled (no pause display) and the trays will remain in their current position. No alarm will sound. This feature is used while using the whole incubator to hatch eggs.

## 10 Egg Setting

10.1 Before setting eggs ensure that the incubator has been run for several hours and has stabilised at the correct temperature.

10.2 Use the standard egg "flats" or Universal Egg Trays as purchased with the incubator to set the eggs on the setting shelves. Load the shelves evenly to avoid overloading the turning system. Eggs should be evenly distributed over each flat or tray to ensure the shelves are balanced. **Note that some egg trays are narrower than others and may slide from side to side on the shelves. This is not something to be concerned about.**

10.3 Eggs may be set on end (or at an angle) provided the large end of the egg is upwards. Eggs rolling through a few degrees as the incubator turns are not in danger.

**Ensure that nothing can restrict the movement of the trays or setting shelves. This may damage the turning mechanism and invalidate the guarantee. Load the setting shelves evenly to help prevent imbalanced operation. ENSURE TRAYS ARE PUSHED TO THE BACK OF EACH SHELF.**

10.4 Once the egg trays have been placed on the shelves close the door.

10.5 Re-start the turning (see section 9 for details).

10.6 Once the eggs have been set the temperature must not be adjusted for 24 hours to allow the eggs to warm. Check the water level every 3 days or so and temperature daily. Candle the eggs after 1/3rd of the incubation period has elapsed to reject clear, infertile eggs (see section 13).

## 11 Periodic Incubation Cooling

Bird breeders have known for many decades that eggs can be cooled for limited periods of time during incubation without causing problems but recent research has shown that hatch rates can increase significantly as a result of cooling. This research was carried out with poultry but it is generally accepted that the benefits can apply to waterfowl too. Cooling is an entirely natural process as most birds will get off the nest at least once a day and leave the eggs unheated for a significant time. From Brinsea's 35 year experience, the best hatch rates are always achieved when the incubator can best mimic the natural nest conditions.

The precise details of which days and what cooling period each day should be used for best effect are not known but Brinsea have assessed the available research and recommend the following daily cooling periods from day 7 through to 2 days before they are due to hatch (the same point that automatic turning would normally be stopped).

Smaller poultry, waterfowl and game bird eggs:	2 hours each day
Larger species eggs (e.g. duck and goose):	3 hours each day

Cooling is not recommended for parrots and birds of prey because the results of cooling haven't yet been established. For further details please visit the Brinsea website at [www.Brinsea.co.uk/cooling](http://www.Brinsea.co.uk/cooling)

- 11.1 The periodic cooling feature turns the incubator's heater and low temperature alarm off for a selectable period but keeps the fans running. After the cooling period is complete the incubator reverts to normal temperature and the alarm is automatically reset.
- 11.2 **SETTING THE COOLING PERIOD.** The cooling function is optional and may be adjusted.
- Press the - and + buttons simultaneously to unlock the Main Menu.
- Press + to scroll to the cooling option.
- Press OK to select the cooling screen.
- Use the + and – buttons to select OFF, 60, 120, 180, 240, 300 or 360 minutes cooling.
- Press OK to accept the figure and then scroll to SAVE and press OK to save the changes.
- 11.3 Each cooling period starts at the same time each day (24 hours between start times). The first cooling period will start after the incubator has been switched on for 24 hours. If there is a power interruption the 24 hour delay starts again.
- 11.4 During the cooling period the heater asterisk goes off and an arrow “↓” is displayed. When the cooling period ends the asterisk is shown and the incubator warms to incubation temperature. The time taken to return to incubation temperature depends on the room temperature and may take 30 or more minutes.

## 12 Hatching

- 12.1 For maximum setting capacity, cleanliness, flexibility and performance use the hatching tray situated in the base of the incubator.
- 12.2 Eggs nearing hatch benefit from a slightly lower temperature. The hatching tray temperature is approximately 1°C (2°F) lower than the setting shelves.
- 12.3 Hatching humidity levels need to be high (see section 8.0 above) but note that the ventilation control must be at least 1/3rd open during hatching if the incubator is fully loaded with eggs.
- 12.4 When most eggs have hatched (12 to 48 hours) it may be recommended to remove the hatchlings to a brooder.
- 12.5 During hatching the high humidity levels will fall dramatically when the door is opened and will take some time to build up. Resist the temptation to open the door frequently – leave for at least 6 hours between inspections.

- 12.6 To assemble the hatching tray(s) place a white plastic peg in each of the four corner sockets on an Ova-Easy universal tray as shown below. The wide end of the peg should make a push fit into the socket. Another universal tray may then be placed upside-down over the narrow end of the pegs to form a secure lid over the hatching eggs. When the lid is removed the pegs will stay fixed in the bottom tray.

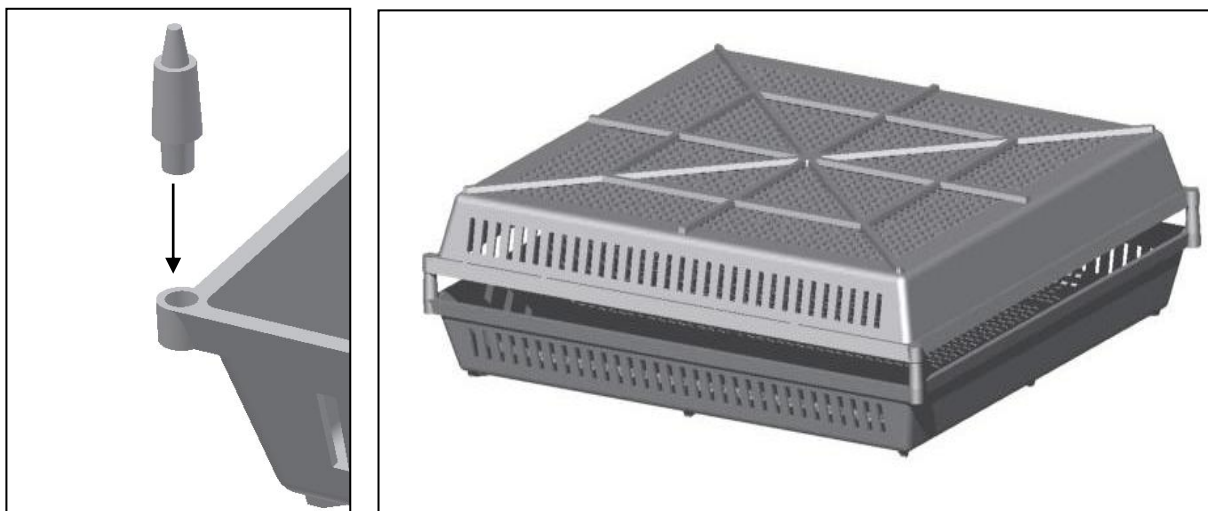

## 13 Cleaning Up

**IMPORTANT:**

DISCONNECT THE INCUBATOR FROM THE MAINS POWER SUPPLY DURING CLEANING.

ENSURE THAT ALL ELECTRICAL PARTS ARE KEPT DRY.

NEVER WASH THE TRAYS, INSULATED PANELS, FASCIA OR EVAPORATION TRAY PARTS WITH LIQUIDS OVER 50°C (120°F). DO NOT USE A DISHWASHER TO CLEAN THESE PARTS.

NEVER ALLOW CLEANING WATER TO COME INTO CONTACT WITH THE TEMPERATURE AND HUMIDITY SENSOR. THIS IS SUSPENDED ON A CABLE BY THE SIDE OF THE WATER EVAPORATION TRAY. CONTAMINATION MAY DAMAGE THE SENSOR.

- 13.1 Following each hatch in the Cabinet Incubator remove and wash the egg tray(s), and most importantly the Hatch Tray in Incubation Disinfectant Solution. Wipe all other internal surfaces with a soft cloth soaked in the solution. Ensure that the instructions supplied with the fluid are followed. Dust and fluff may be removed from the fan guard area with a soft brush.
- 13.2 If a separate hatcher is used the procedure above should still be followed every two months.
- 13.3 The exterior of the incubator may be cleaned with a damp cloth. Avoid allowing any moisture to get inside the top electrical housing or electrical connector at rear.
- 13.4 Always clean the incubator before storage and ensure that the unit is totally dry inside and out.

## 14 Troubleshooting

- 14.1 Poor hatching results are frustrating and can be caused by a large number of factors. The most common are given below. Brinsea Products will not be held responsible for loss of eggs or chicks under any circumstances. A wealth of advice and information is available on our website:- [www.brinsea.com](http://www.brinsea.com)
- 14.2 Gather as much information from the hatching results as possible to enable the problem to be analysed in detail. Record dates that eggs are set, incubator settings, dates of hatches, weight losses and the number and condition

of hatchlings. Candle or break open unhatched eggs to estimate the extent of embryo development. The Brinsea OvaView and High Intensity OvaView candling lamps are available from your dealer.

14.3 Many hatching problems are associated with incorrect humidity. Consider upgrading to EX specification to give better control of humidity. Go to [www.brinsea.com](http://www.brinsea.com) for details.

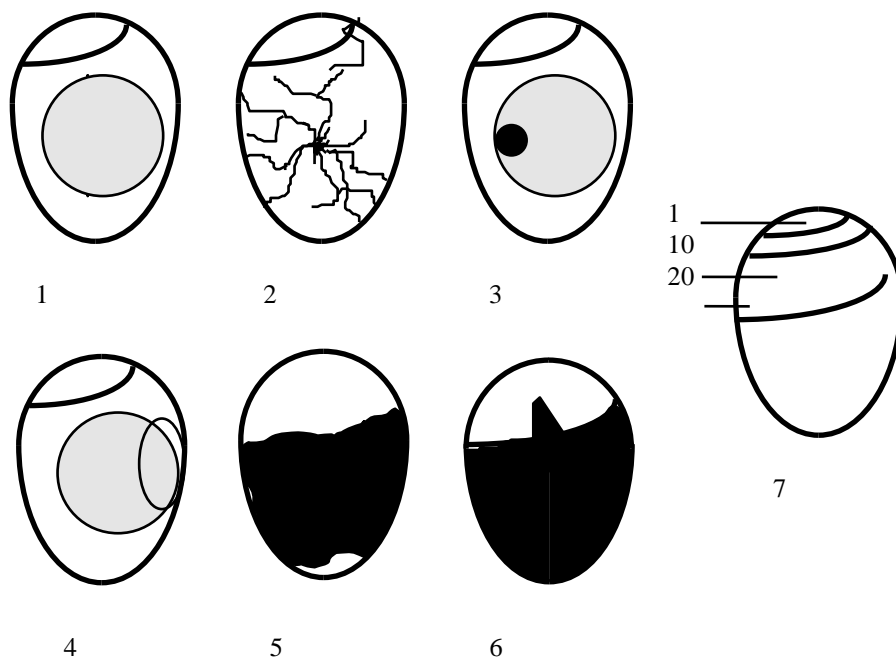

1) Clear when candled - probably infertile (or very early death) when candled at 8 days

2) Fertile with red blood vessels - after 8 days

3) Red or black staining - early death when candled at 8 days

4) Embryo with red blood 'ring' - early death when candled at 8 days

5) Dark outline with ill defined detail - late death (10-16 days)

6) Live embryo with bill in air sack - due to hatch in 24-48 hours

7) Normal development of the air pocket according to number of days

14.4 General guides:

Observation	Likely Cause(s)	Solution(s)
No chicks hatch	Infertility, infection, drastically incorrect incubation settings, parent ill health.	Check egg viability – are similar eggs hatching naturally. Disinfect the incubator. Check incubator settings and procedures – particularly temperature.
Chicks hatch earlier than expected, deformities.	Incubation temperature too high	Reduce incubation temperature slightly 0.5°C (1°F)
Chicks hatch later than expected	Incubation temperature too low	Raise incubation temperature slightly 0.5°C (1°F)
Hatch dates widely spread	Different rates of development due to different storage times, incubation temperature variation.	Limit egg storage times. Check for incubation temperature variation – sunlight, large room variation etc.
Late stage 'death in shell'	Incorrect humidity, probably too high.	Try reducing average humidity levels (but see section 6 above)
Generally poor results	Incorrect incubation settings, poor parent bird health, inadequate egg turning,	Improve parent bird health, check all incubation settings, analyse egg weight loss to confirm humidity correct, check turning working correctly.

## 15 Servicing and Calibration

**IMPORTANT: THE HEATER AND CONTROL SYSTEM ARE AT MAINS VOLTAGE. NEVER ATTEMPT ANY KIND OR FORM OF SERVICING UNLESS THE MACHINE IS DISCONNECTED FROM THE MAINS ELECTRICITY SUPPLY. RISK OF ELECTRIC SHOCK!**

- 15.1 Under certain conditions it is possible that condensation may form on the inner walls. The presence of water gathering at the base of the incubator does not affect the performance of your incubator and does not pose an electrical hazard.
- 15.2 In case of failure first check that the mains power supply is working and that the mains cable connector is fully engaged in the socket on the rear panel. The digital control system may be reset to the original factory defaults by connecting the power supply while holding the OK button. Check temperature calibration after resetting to defaults.
- 15.3 If the problem persists contact your distributor or Brinsea Products Service Dept.
- 15.4 The functional parts of the Ova-Easy Advance incubators are modular and parts are available and are readily exchanged by a suitably qualified person equipped with basic tools. Fitting instructions are supplied with replacement parts.
- 15.5 The digital temperature and humidity display is individually calibrated during manufacture but may be recalibrated if required. It is **NOT RECOMMENDED** that this procedure is carried out by the user.

BE CAUTIOUS OF LOW COST ANALOGUE OR DIGITAL THERMOMETERS AND HYGROMETERS.

BRINSEA PRODUCTS LTD USES SOPHISTICATED EQUIPMENT TRACEABLE TO INTERNATIONAL REFERENCE STANDARDS.

To access the Calibration Menu press all three buttons simultaneously to unlock the display.

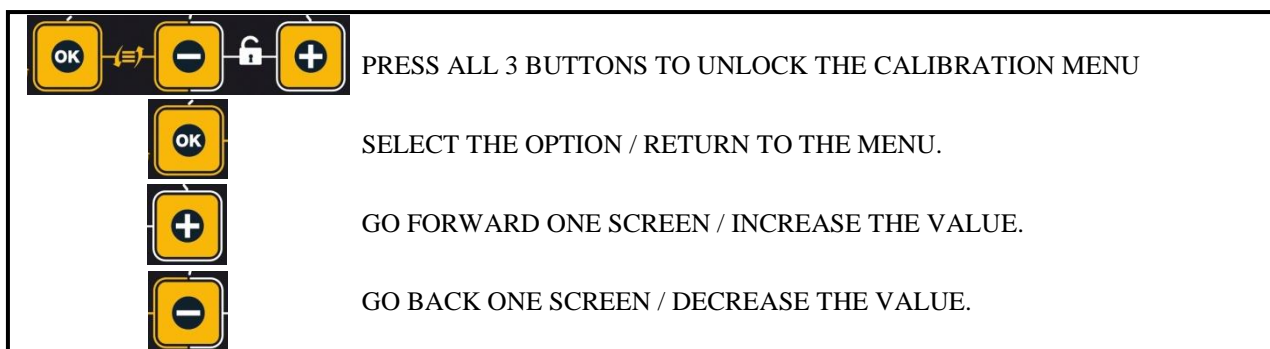

# CALIBRATION MENU

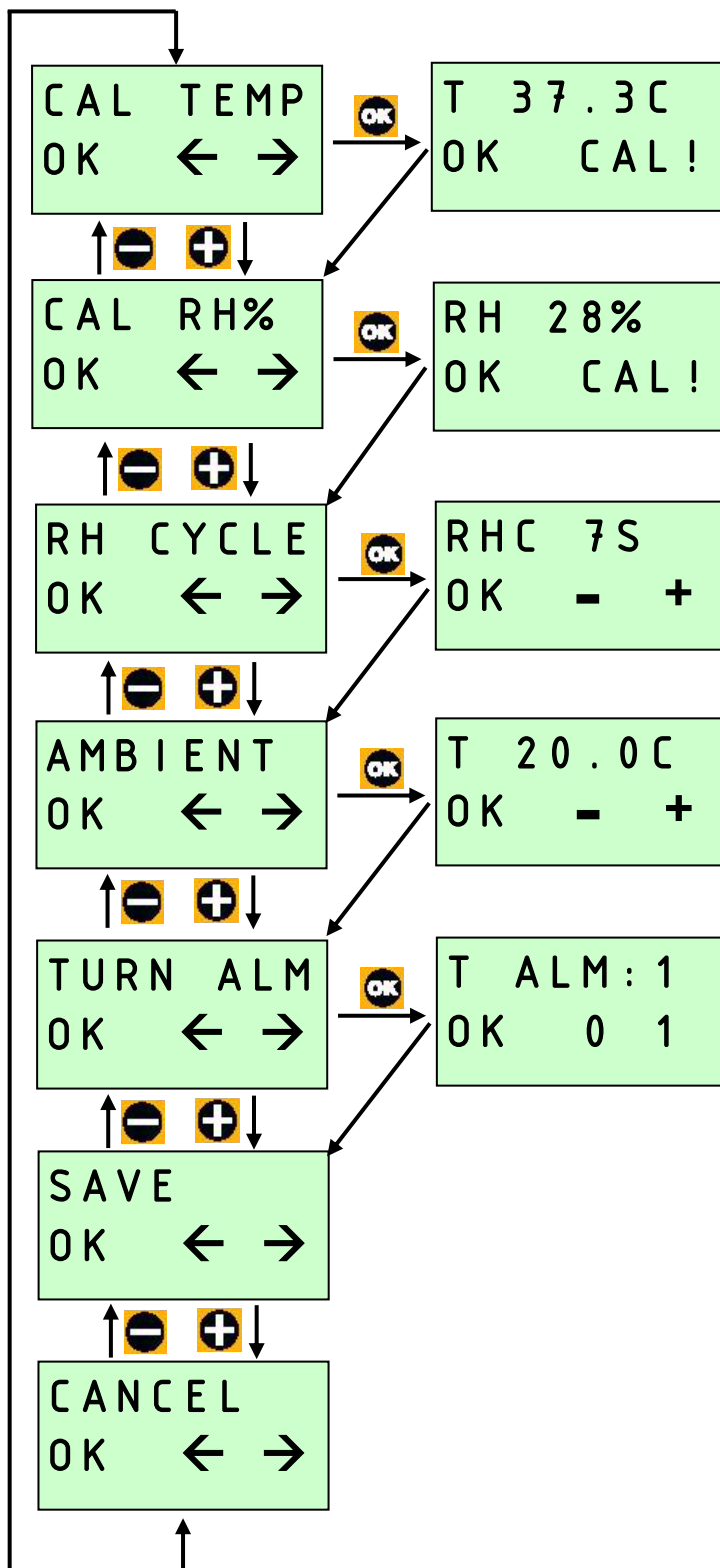

**CALIBRATE THERMOMETER.**  
TAKE READINGS AT 30mm ABOVE THE CENTRE OF EACH EGG TRAY AND CALCULATE THE AVERAGE.

**CALIBRATE HYGROMETER.**  
PLACE HYGROMETER IN CENTRE WITH NO WATER IN THE EVAPORATING TRAY.

**HUMIDITY PUMP CYCLE TIME.**  
ONLY APPLICABLE WHEN USED WITH THE BRINSEA ADVANCE HUMIDITY PUMP.

**AMBIENT TEMPERATURE COMPENSATION.**  
AMBIENT TEMPERATURE USED IN HEATER CONTROL ALGORITHM. ONLY ADJUST IF DISPLAY VARIES BY MORE THAN +/- 0.2°C.

**TURN ALARM.**  
SWITCHES THE TURN WARNING ALARM OFF IF CAUSING A DISTURBANCE. IT IS RECOMMENDED TO LEAVE THIS SWITCHED ON.



## 16 Specification

### Maximum Approximate Setting Capacities (includes use of hatching trays and special inserts):

<b>Egg size</b>	<b>Ova-Easy 190 Advance</b>	<b>Ova-Easy 380 Advance</b>
Quail	869	1738
Pheasant	233	466
Hen	192	384
Duck	104	280
Goose	57	114

### Dimensions:

190 Advance	820 x 420 x 480mm (32.5" x 16.5" x 19") HxWxD
380 Advance	820 x 420 x 800mm (32.5" x 16.5" x 31.5") HxWxD

### Weight:

190 Advance, Incubator only	20Kg
380 Advance, Incubator only	27Kg

### Power Consumption:

Maximum	200 Watts
(typical average)	100 Watts

**Electrical Supply:** 230v 50Hz or 110V 60Hz (as ordered)

**Brinsea Products Ltd, Station Road, Sandford, N. Somerset, BS25 5RA, England**  
**Tel 0845 226 0120, Fax 01934 820250, email sales@brinsea.co.uk**